

INDEX

EQUIPMENT

Country Clipper.....	102-103
Earthway Lawn Spreaders.....	84-85
Echo Handheld.....	101
Encore ZTR Mowers.....	88-89
EZ Trench.....	90
Grasscatcher - Accelerator.....	104
Hydro Clean Pressure Washer.....	86
MacKissic/Mighty Mac	92-97
Mower Lift - Prolift.....	90
Ramps - Ohio Steel, Oxlite.....	91
Solo Sprayers.....	98-99
Toro Lawnmowers.....	100
Wobbler Sprinklers.....	81
Z-Trimmer Attachment.....	87

ORIGINAL ENGINES & PARTS

Briggs & Stratton.....	44-47
Honda.....	42-43
Kawasaki.....	48-51
Kohler.....	52-68
Tecumseh.....	53

CHAINSAW CHAIN, BARS, PARTS

Carlton.....	20-31
Laser.....	8, 32-33
Pfred Sharpeners.....	9
Top Saw Chainsaw Tool.....	34
Trilink.....	10-19

FUELS, OILS & ACCESSORIES

B3C -Ethanol Shield, Mech/Bottle.....	6-7
Bar & Chain Oil.....	34
DrainZit Hoses.....	5
Funnels Clean Brand.....	77
Fluid Film Lubricant.....	73
Kawasaki Oil.....	49
Mo-Deck Grass Repellant.....	70
OPTI 2 & 4 cycle oil.....	2-3
SEF / VP Fuel & Tanks.....	4

GLOVES, SAFETY GLASSES

Atlas.....	75
Elvex.....	76

HAND TOOLS

EZ Kut Loppers.....	80
Groundskeeper Rakes.....	79
Milwaukee	104
Noco Genius Jump Start Booster.....	82

SHOP TOOLS / MISCELLANEOUS

ESA Shop Forms.....	77
Grassbuster Tool.....	70
Rope Ratchet Tie Downs.....	83
Service manuals.....	69
Shop towels - Torx.....	78
Whip Battery Protectant.....	71

TIRE SEALANT & ACCESSORIES

Amerseal.....	71
Linseal.....	73
Nealy Tire Kits.....	72

TRIMMER LINE & ACCESSORIES

Carlton Trimmer Line.....	74
Rino Tuff Trimmer Head.....	74

CLOSEOUT EQUIPMENT..... 105

CREDIT APPLICATION..... 106-108

ROTARY AFTERMARKET PARTS..... 35-41



PHONE (800) 569-2700



**PERFORMANCE
LUBRICANTS**

**EXCEEDS ALL ENGINE
MANUFACTURERS
WARRANTY REQUIREMENTS
API SH/CD**

Opti-4 -- DOUBLES Engine warranties

Opti-4 is the only oil that is so effective it doubles the OEM engine warranty.--Abrasion free run-in--Dramatic surface improvement--Lower operating temperatures--Easier starting--Longer engine life -- Off season corrosion protection

4 CYCLE LUBRICANTS

ITEM #	DESCRIPTION	#CASE	RETAIL
40524	20 oz. bottle 5W30	24	\$ 12.66
43024	20 oz. bottle 30W	24	\$ 12.66
43121	34 oz. bottle 10W30	12	\$ 17.25
43141	34 oz. bottle 10W40	12	\$ 17.25
43444	1 gallon jug 30W	4	\$ 65.98
*40544	1 gallon jug 5W30	4	\$ 62.95
43120	5.3 gallon pail 30W		\$ 288.00
43455	55 gallon drum 30W		\$2075.00

***LIMITED AVAILABILITY**

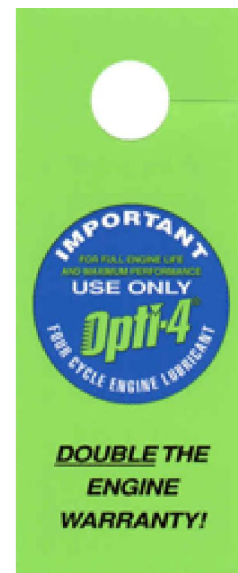

Enviro Formula 2 cycle lubricant

When it comes to making the best environmental choice, OPTI-2 is the cleanest two cycle oil available. *Opti-2 exceeds the highest worldwide performance standard E-GD+ and is fully compatible with oxygenated fuels.*

OPTI-2 --A single mix for ALL 2 cycle engines

--Increased performance and longer engine life -- Smoke free operation -- Contains fuel stabilizer



2 CYCLE LUBRICANTS

ITEM #	DESCRIPTION	#BOX	RETAIL
20096	1.8 oz. pouch(mixes1 gal.)	48	\$ 2.10
20612	Pro Tube containing 6-20096		\$ 12.59
20056	3.2oz. pouch (mixes2.5 gal.)	28	\$ 3.15
21212	12 oz. bottle (mixes 10 gal.)	12	\$ 11.49
20112	34oz.EZ Meas.(mixes 25 gal.)	12	\$ 25.99
20044	1 gallon jug (mixes 100 gal)	4	\$ 73.49
21624	Opti 2 Pump(dispenses 1 gal.)		\$ 10.49
20015	5.3 gallon pail (mixes 530 gal.)		\$ 315.00
20055	55 gallon drum (mixes 5300 gal.)		\$2625.00

OP20096 & OP20056 ARE 2 BOXES PER CASE!



#20612
Pro Tubes contains
6 pouches of 20096.

FAX (800) 489-4804



Opti-Mizer -- 24 Month Fuel Stabilizer

--Keeps fuel fresh -- Prevents resin and gums -- Protects entire fuel systems
 --Detergent package -- Contains exclusive Valve Guard upper cylinder lubrication



<u>OPTIMIZER</u>			
ITEM #	DESCRIPTION	#CASE	RETAIL
60612	6 pks 1.4oz (treats 30 gal)	12	\$ 11.95
61612M	16 oz EZ Meas (treats 60 gal)	12	\$ 17.95
60044	1 gallon Jug (treats 485 gal)	4	\$ 79.95
61624	Opti Max Pump for gal. jug		\$ 9.95
96812	Opti Max Display 8-6pks, (12-16oz bottles)		\$311.00

Opti-2 Injector Oil

--One injector oil for ALL engines in ALL seasons -- Formulated to ensure optimum flow --
 Cleaner operation , no plug fouling -- Lowest friction coefficient



<u>INJECTOR OIL</u>			
ITEM #	DESCRIPTION	#CASE	RETAIL
30112	34 oz. bottle	12	\$ 16.99
30044	1 gallon jug	4	\$ 61.99
30015	5.3 gallon pail		\$ 250.00
30055	55 gallon drum		\$2100.00

STARTER KITS & RACKS

ITEM #	DESCRIPTION	RETAIL
92176	Opti-2 Power Tower Contains 3 boxes (48) OP20096 1 gal. pouches, 1 box (28) 2.5 gal pouches	\$ 419.00
90200F	Display Rack with Product Contains (48)OP20096, (6) OP20612, (28) OP20056, (12) OP21212, (6) OP20112, (24) OP43024, (8) OP43121, (2) OP43444, and metal rack with signs	\$1101.66
90200E	Display Rack without Product	\$ 141.82



PHONE (800) 569-2700



THE BEST SOLUTION TO ETHANOL-RELATED PROBLEMS AND OPTIMUM PERFORMANCE IN:
Lawnmowers • Trimmers • Blowers • Generators • Chain Saws • Splitters • And More!



PART #	DESCRIPTION
QUARTS	
SEF94	4 Stroke Unleaded Fuel (6 / case)
SEF9440	2 Cycle Pre-Mixed 40:1 Gas Oil Mix (6 / case)
SEF9450	2 Cycle Pre-Mixed 50:1 Gas Oil Mix (6 / case)
1 GALLON CANS	
SEF94-1	4 Stroke Unleaded Fuel - 1 Gallon Can
SEF9440-1	2 Cycle Pre-Mixed 40:1 Gas Oil Mix - 1 Gallon Can
SEF9450-1	2 Cycle Pre-Mixed 50:1 Gas Oil Mix - 1 Gallon Can
5 GALLON BUCKETS	
SEF94-5	4 Stroke Unleaded Fuel - 5 Gallon Bucket
SEF9440-5	2 Cycle Pre-Mixed 40:1 Gas Oil Mix - 5 Gallon
SEF9450-5	2 Cycle Pre-Mixed 50:1 Gas Oil Mix - 5 Gallon
54 GALLON BARREL	
SEF94-54	4 Stroke Unleaded Fuel - 54 Gallon Barrel
SEF9440-54	2 Cycle Pre-Mixed 40:1 Gas Oil Mix - 54 Gallon
SEF9450-54	2 Cycle Pre-Mixed 50:1 Gas Oil Mix - 54 Gallon

CALL FOR
CURRENT
PRICING



We CANNOT ship these products by UPS or US MAIL, Orders will be delivered via salesman depending on their scheduled routes.



PART #	DESCRIPTION	RETAIL
SEF 3G TANK	3 Gallon Tank	\$26.00
SEF TANK W/ HOSE	5 Gallon Tank w/ hose	\$32.00
SEF HOSE	Hose Standard	\$ 8.50
SEF POWER SPOUT S	Spout for 5 gallon cans	\$24.99
VPEZSPOUT	EZ Pour spout 1 gal	\$ 2.99

orders@boettchersupply.com

Drainzit™ Oil Drain Hoses

Drainzit oil hoses make changing oil easier and cleaner! Drainzit is easy to install, simple to use and requires no engine modification. Although, originally built for Honda engines, Drainzit works on almost all brands of gas engines from Kawasaki to Kohler to Briggs & Stratton.



PART #	PORT SIZE	FITS	RETAIL	DEALER
1/4" Hose Fitting:				
HON1010	10mm	Honda: G100GX120,GX160,GX200 Kohler: CS4, CS6	\$17.50	
HON1012	12mm	Honda: GX240,GX270,GX340,GX390 Honda: GC160; Kohler:CS.8,CS10,CS10	\$17.50	
HON 1014	14mm	Honda V-Twin, some Kawasaki	\$18.00	
STAN1025	1/4"	Most Briggs & Tecumseh engines w/ 1/4" pipe thread	\$17.00	
3/8" Hose Fitting:				
HON1414	14mm	Honda: V-Twin, Kawasaki	\$19.00	
HON1420	20mm	Honda: GXV530,610,620,670	\$20.00	
STAN1438	3/8"	Most Briggs & Tecumseh Kohler Command & OHC	\$19.85	
1420-K	20mm	Kohler Command & Kawasaki	\$21.50	

PHONE (800) 569-2700



PROTECT Fuel Systems

FIX Poor / Non-Running Engines

PREVENT Future Engine Problems

B3C FUEL TREATMENT GASOLINE

PART #	DESCRIPTION	RETAIL
DEALER SERVICE KITS - GAS		
9-761-1	Contains: (24) Ethanol Shield 4oz, (24) Mechanic In A Bottle 4oz, (6) Gas Tank Shield Snakes, (12) MIB Gas Dual Swabs, (24) Ethanol Shield 50:1 Mix	\$459.99
ETHANOL SHIELD - GAS		
1-004-12	4oz Ethanol Shield in Display Tray (12 in tray)	\$ 6.59
1-008-9	8oz Ethanol Shield	\$ 9.49
1-024-6	24oz Ethanol Shield	\$ 18.99
1-128-4	1 Gallon Jug Ethanol Shield	\$ 99.99
MECHANIC IN A BOTTLE - GAS		
2-004-12	4oz Mechanic in Bottle Display Tray (12 in tray)	\$ 6.59
2-008-9	8oz Mechanic In Bottle	\$ 9.49
2-024-6	24oz Mechanic in Bottle	\$ 18.99
2-128-4	1 Gallon Jug Mechanic in Bottle	\$ 89.99
COMBO PACKS - GAS		
5-002-18	2oz Combo Pack Ethanol Shield/Mechanic In Bottle	\$ 7.49
TANK SNAKES - GAS		
6-001-12	Tank Snake Water Extractor - Single	\$ 7.49
TEST KITS - GAS		
9-019-6	Gas Repair Kit	\$ 11.50
7-009-9	Mechanic In Bottle Test Swabs - 100 Count	\$ 54.99
7-001-24	Mechanic in Bottle Test Swabs - 5 Pack	\$ 3.99
ETHANOL SHIELD 2-CYCLE OIL		
12-026-24	2-cycle oil w/ Ethanol Shield, 2.6oz - 24pk)	\$ 2.49

FAX (800) 489-4804



ENGINE ENERGY

Seven Fuel Additives in One



**FIX & PROTECT
Diesel Systems**

PART #	DESCRIPTION	RETAIL
ENGINE ENERGY - CLEANS INJECTORS, INCREASES MILEAGE		
4-004-12	4oz Engine Energy Octane Booster (12 in tray)	\$ 6.59
4-008-9	8oz Engine Energy Octane Booster (9 in tray)	\$ 8.99
4-128-4	128 oz Engine Energy Octane Booster	\$ 89.99
2-018-6AM	18oz Mechanic in a Bottle AUTO/MARINE (16 in tray) 	\$ 9.99
MULTI-SHIELD - Rust protectant, cleaner, All-In-One		
13-016-6	15 oz Spray Bottle, seals and protects surfaces from rust, corrosion, water, UV rays, etc while renewing the look of the surface.	\$ 11.99

**B3C FUEL TREATMENT
DIESEL**

PART #	DESCRIPTION	RETAIL
MECHANIC IN A BOTTLE - DIESEL		
3-004-12	4oz DIESEL Mechanic In Bottle in Display Tray (12 in tray)	\$ 6.59
3-008-9	8oz DIESEL Mechanic In Bottle	\$ 9.49
3-024-6	24oz DIESEL Mechanic In Bottle	\$ 18.99
3-128-4	1 Gallon Jug DIESEL Mechanic In Bottle	\$ 99.99
8-305-1	5 Gallon Pail DIESEL Mechanic In Bottle	\$389.00
ANTI-GEL MECHANIC IN A BOTTLE - DIESEL		
14-024-6	DIESEL Anti-Gel Quart Bottle (6 in case)	\$ 11.99
14-128-4	DIESEL Anti-Gel Gallon Jug	\$ 54.99
REPAIR KITS- DIESEL		
9-018-4	DIESEL Tractor Repair Kit	\$ 74.99
9-017-4	DIESEL Truck Repair Kit	\$ 84.99
TANK SNAKES - DIESEL		
6-024-6-XT	24" / 1" Diameter Red Tractor Tank Snake	\$ 31.95
6-012-6-X	12" / 1" Diameter Black Tank Snake	\$ 27.99
6-024-6-X	24" / 2" Diameter Black Tank Snake	\$ 41.99

PHONE (800) 569-2700

LASER

Chainsaw Grinders

CHAINSAW

PART #	DESCRIPTION	RETAIL
47228	Hobbyist Mini Grinder <ul style="list-style-type: none"> • Sharpens 1/4" to .404 chain • Comes w/ 1/8" grinding wheel • Ideal for sharpening semi-chisel Cutters 	\$ 65.93



47228

PART #	DESCRIPTION	RETAIL
47227	Professional Grinder <ul style="list-style-type: none"> • Permanently attachable • High-performance motor • Rotating tensioning device and grinding head • Illumination of the sharpening zone • Comes with 3 grinding wheels 	\$181.65



47227

PART #	DESCRIPTION	RETAIL
47993	Jolly Star Grinder <ul style="list-style-type: none"> • Newly Designed self-centering vice ensures accuracy & consistent sharpening • Sharpens all size chain from 1/4" to 3/4" • Comes with 3 grinding wheels 	\$512.58

DOES 3/4 PITCH



47993

PART #	DESCRIPTION	RETAIL	DEALER
47320	Super Jolly Star Grinder <ul style="list-style-type: none"> • Designed exclusively for Pro Cutters • Provides increased sharpening speed over manual models • Shortens sharpening time by 40% • Comes with 3 grinding wheels 	\$609.16	



47320



Grinding Wheels for C.....

Part #	Thick	Chain Pitch
32-4252	3/16"	3/8", .354", .404
32-4253	1/8"	1/4", .325", 3/8" mini
32-4254	1/4"	depth guage

RETAIL - \$27.23

Carlton Grinding Wheels

High Quality aluminum oxide wheels resist burning and produce a smooth finish.

PART#	RETAIL
#13C1032	\$35.82
For 1/4", .325", 3/8" LP	
#13C1047	\$39.93
For 3/8" STD. .404"	
#13C1060	\$39.93
For 1/2" and depth gauges	

orders@boettchersupply.com

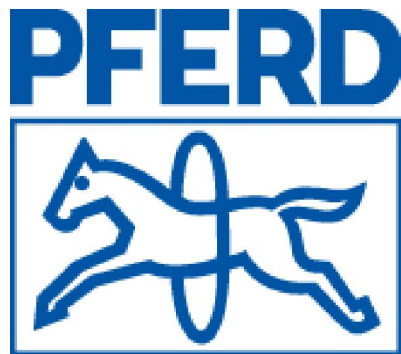

PFERD manufactures the highest quality chain saw files in the world. Their uniform steel structure, correct hardness, exact shaping and even tooth spacing guarantee maximum cutting performance. This greatly reduces labor time and puts a perfect edge on saw chains every time. The size and type of chain as well as the degree of wear will determine which file to use.

CHAINSAW

PART #	DESCRIPTION	RETAIL	DEALER
CSX CHAIN CHARPENERS - Sharpening with CHAIN SHARP CS-X guarantees longer durability and use of the saw chain. No time-consuming conversion, simply change from left to right tooth by turning the device.			
17300	5/32" files for 3/8LP	\$34.95	
17301	3/16" files for .325	\$34.95	
17303	13/64" files for 3/8	\$34.95	
17304	7/32" files for 3/8", .404	\$34.95	
17310	Rplmt Depth Gauge File	\$ 9.25	
BAR EDGE SHARPENER - This general-use chamfer file is ideal for removing burrs from workpiece edge areas. Special mounting ensures easy tool control.			
13025	Universal Edge Sharpener	\$24.95	
13026	replacement File	\$11.75	
FILE CARDS - For easy cleaning of chip-loaded files. Rugged wooden handle with wear-resistant steel wire filing.			
17146	File Card Only	\$20.24	
17147	File Card with Brush	\$28.62	
FILES			
17044	8" Flat File	\$14.28	
17081	7" 3 Square File	\$16.50	

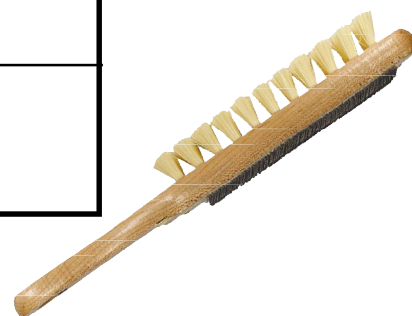

CUT OFF WHEEL FOR PORTABLE/GAS SAWS		
<u>PERFORMANCE LINE FOR STEEL</u>		
64010	12"x1/8"x20mm 100m/s	\$ 7.75
64015	12"x1/8"x1" 100m/s	\$ 7.75
64016	14"x3/16"x20mm 100m/s	\$13.59
64018	14"x3/16"x1" 100m/s	\$13.59
<u>PERFORMANCE LINE FOR DUCTILE IRON</u>		
64118	12"x1/8"x20mm 100m/s	\$ 8.49
64123	14"x3/16"x20mm 100m/s	\$14.59



PHONE (800) 569-2700



TRLINK BULK CHAIN NUMBERING SYSTEM

EXAMPLE: 14BR100NSTP				
1	43	BR	100	NS
Pitch & Cutter	Gauge		Length	
1 = 3/8LP	43 = .043	BULK	100 = 100 FT	Non-Safety
2 = .325" Semi-Chisel	50 = .050		25 = 25 ft	
3 = 3/8" Semi-Chisel	58 = .058			
4 = .040" Semi-Chisel	63 = .063			
6 = 3/8LP Chisel				
7 = .325" Chisel				
8 = 3/8" Chisel				

CARLTON TO TRILINK CROSS			
N4C	3/8LP .043 Semi-Chisel		143
N1C	3/8LP .050 Semi-Chisel		150
N/A	3/8LP .050 Chisel		650
K1C	.325" .050 Semi-Chisel		250
K2C	.325" .058 Semi-Chisel		258
K3C	.325" .063 Semi-Chisel		263
K1L	.325" .050 Chisel		750
K2L	.325" .058 Chisel		758
K3L	.325" .063 Chisel		763
A1EP	3/8" .050 Semi-Chisel		350
A2EP	3/8" .058 Semi-Chisel		358
A3EP	3/8" .063 Semi-Chisel		363
A1LM	3/8" .050 Chisel		850
A2LM	3/8" .058 Chisel		858
A3LM	3/8" .063 Chisel		863
B2EP	.404" .058 Semi-Chisel		458
B3EP	.404" .063 Semi-Chisel		463

Number of Drivers in Reels		
PITCH	25 FT	100 FT
3/8" Lo-Pro	410	1635
.325"	462	1840
3/8"	410	1635
.404"	372	1480





CHAINSAW

TRILINK PART #	STYLE	LENGTH	PITCH	GAUGE	RETAIL
143BR100NSTP	Semi-Chisel	100ft	3/8LP	0.043	\$240.00
143BR25NSTP	Semi-Chisel	25ft	3/8LP	0.043	\$ 70.00
150BR100NSTP	Semi-Chisel	100ft	3/8LP	0.050	\$240.00
150BR25NSTP	Semi-Chisel	25ft	3/8LP	0.050	\$ 70.00
650BR100NSTP	Chisel	100ft	3/8LP	0.050	\$249.00
650BR25NSTP	Chisel	25ft	3/8LP	0.050	\$ 70.00
350BR100NSTP	Semi-Chisel	100ft	3/8"	0.050	\$285.00
350BR25NSTP	Semi-Chisel	25ft	3/8"	0.050	\$ 78.00
358BR100NSTP	Semi-Chisel	100ft	3/8"	0.058	\$285.00
358BR25NSTP	Semi-Chisel	25ft	3/8"	0.058	\$ 78.00
363BR100NSTP	Semi-Chisel	100ft	3/8"	0.063	\$285.00
363BR25NSTP	Semi-Chisel	25ft	3/8"	0.063	\$ 78.00
850BR100NSTP	Chisel	100ft	3/8"	0.050	\$315.00
850BR25NSTP	Chisel	25ft	3/8"	0.050	\$ 86.00
858BR100NSTP	Chisel	100ft	3/8"	0.058	\$315.00
858BR25NSTP	Chisel	25ft	3/8"	0.058	\$ 86.00
863BR100NSTP	Chisel	100ft	3/8"	0.063	\$315.00
863BR25NSTP	Chisel	25ft	3/8"	0.063	\$ 86.00
250BR100NSTP	Semi-Chisel	100ft	0.325"	0.050	\$285.00
250BR25NSTP	Semi-Chisel	25ft	0.325"	0.050	\$ 78.00
258BR100NSTP	Semi-Chisel	100ft	0.325"	0.058	\$285.00
258BR25NSTP	Semi-Chisel	25ft	0.325"	0.063	\$ 78.00
263BR100NSTP	Semi-Chisel	100ft	0.325"	0.063	\$285.00
263BR25NSTP	Semi-Chisel	25ft	0.325"	0.063	\$ 78.00
750BR100NSTP	Chisel	100ft	0.325"	0.050	\$315.00
750BR25NSTP	Chisel	25ft	0.325"	0.050	\$ 86.00
758BR100NSTP	Chisel	100ft	0.325"	0.058	\$315.00
758BR25NSTP	Chisel	25ft	0.325"	0.058	\$ 86.00
763BR100NSTP	Chisel	100ft	0.325"	0.063	\$315.00
763BR25NSTP	Chisel	25ft	0.325"	0.063	\$ 86.00
458BR100NSTP	Semi-Chisel	100ft	.404"	0.058	\$308.00
458BR25NSTP	Semi-Chisel	25ft	.404"	0.058	\$ 90.00
463BR25NSTP	Semi-Chisel	25ft	.404"	0.063	\$ 90.00
HV80BR100TL	Semi-Chisel	100ft	.404"	0.080	\$434.00

3/8 LP

3/8" Standard

.325"

.404"

PHONE (800) 569-2700

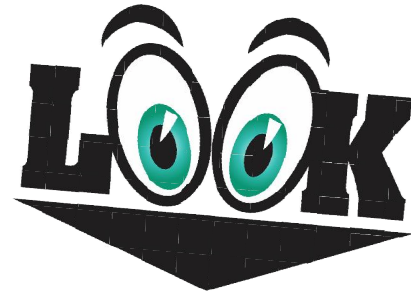

3/8LP FULL CHISEL -- NEW!! -- NEW!! -- NEW!!

<i>PART #</i>	<i>STYLE</i>	<i>PITCH</i>	<i>GAUGE</i>	<i>DRIVERS</i>	<i>RETAIL</i>
65050NSTP	CHISEL	3/8LP	0.050	50	\$11.29
65052NSTP	CHISEL	3/8LP	0.050	52	\$11.71
65055NSTP	CHISEL	3/8LP	0.050	55	\$12.43
65056NSTP	CHISEL	3/8LP	0.050	56	\$12.65
65057NSTP	CHISEL	3/8LP	0.050	57	\$12.88
65062NSTP	CHISEL	3/8LP	0.050	62	\$14.04

3/8LP SEMI CHISEL - 043 GAUGE

<i>PART #</i>	<i>STYLE</i>	<i>PITCH</i>	<i>GAUGE</i>	<i>DRIVERS</i>	<i>RETAIL</i>
14340NSTP	SEMI-CHISEL	3/8LP	0.043	40	\$ 8.38
14344NSTP	SEMI-CHISEL	3/8LP	0.043	44	\$ 9.19
14350NSTP	SEMI-CHISEL	3/8LP	0.043	50	\$10.42
14355NSTP	SEMI-CHISEL	3/8LP	0.043	55	\$11.47

3/8LP SEMI CHISEL - .050 GAUGE

<i>PART #</i>	<i>STYLE</i>	<i>PITCH</i>	<i>GAUGE</i>	<i>DRIVERS</i>	<i>RETAIL</i>
15040NSTP	SEMI-CHISEL	3/8LP	0.050	40	\$ 8.38
15044NSTP	SEMI-CHISEL	3/8LP	0.050	44	\$ 9.19
15045NSTP	SEMI-CHISEL	3/8LP	0.050	45	\$ 9.40
15050NSTP	SEMI-CHISEL	3/8LP	0.050	50	\$10.42
15052NSTP	SEMI-CHISEL	3/8LP	0.050	52	\$10.80
15055NSTP	SEMI-CHISEL	3/8LP	0.050	55	\$11.47
15056NSTP	SEMI-CHISEL	3/8LP	0.050	56	\$11.65
15057NSTP	SEMI-CHISEL	3/8LP	0.050	57	\$11.85
15062NSTP	SEMI-CHISEL	3/8LP	0.050	62	\$12.95

.325 SEMI CHISEL

<i>PART #</i>	<i>STYLE</i>	<i>PITCH</i>	<i>GAUGE</i>	<i>DRIVERS</i>	<i>RETAIL</i>
25066NSTP	SEMI-CHISEL	0.325	0.050	66	\$16.44
25072NSTP	SEMI-CHISEL	0.325	0.050	72	\$16.44
25078NSTP	SEMI-CHISEL	0.325	0.050	78	\$17.78
25866NSTP	SEMI-CHISEL	0.325	0.058	66	\$15.09
25872NSTP	SEMI-CHISEL	0.325	0.058	72	\$16.44
26367NSTP	SEMI-CHISEL	0.325	0.063	67	\$15.30
26374NSTP	SEMI-CHISEL	0.325	0.063	74	\$16.87
26381NSTP	SEMI-CHISEL	0.325	0.063	81	\$18.50



.325 FULL CHISEL

<i>PART #</i>	<i>STYLE</i>	<i>PITCH</i>	<i>GAUGE</i>	<i>DRIVERS</i>	<i>RETAIL</i>
75066NSTP	CHISEL	0.325	0.050	66	\$16.56
75072SNTP	CHISEL	0.325	0.050	72	\$18.12
75078NSTP	CHISEL	0.325	0.050	78	\$19.60
75866NSTP	CHISEL	0.325	0.058	66	\$16.56
75872NSTP	CHISEL	0.325	0.058	72	\$18.12
76362NSTP	CHISEL	0.325	0.063	62	\$15.60
76367NSTP	CHISEL	0.325	0.063	67	\$16.86
76368NSTP	CHISEL	0.325	0.063	68	\$17.12
76374NSTP	CHISEL	0.325	0.063	74	\$18.54
76381NSTP	CHISEL	0.325	0.063	81	\$20.34

3/8 STANDARD SEMI CHISEL

<i>PART #</i>	<i>STYLE</i>	<i>PITCH</i>	<i>GAUGE</i>	<i>DRIVERS</i>	<i>RETAIL</i>
35066NSTP	SEMI-CHISEL	3/8	0.050	66	\$17.06
35068NSTP	SEMI-CHISEL	3/8	0.050	68	\$17.58
35070NSTP	SEMI-CHISEL	3/8	0.050	70	\$18.12
35072NSTP	SEMI-CHISEL	3/8	0.050	72	\$18.66
35084NSTP	SEMI-CHISEL	3/8	0.050	84	\$21.69
35868NSTP	SEMI-CHISEL	3/8	0.058	68	\$17.58
35872NSTP	SEMI-CHISEL	3/8	0.058	72	\$18.66
36372NSTP	SEMI-CHISEL	3/8	0.063	72	\$18.66

3/8 STANDARD FULL CHISEL

<i>PART #</i>	<i>STYLE</i>	<i>PITCH</i>	<i>GAUGE</i>	<i>DRIVERS</i>	<i>RETAIL</i>
85060NSTP	CHISEL	3/8	0.050	60	\$17.12
85068NSTP	CHISEL	3/8	0.050	68	\$19.29
85070NSTP	CHISEL	3/8	0.050	70	\$19.92
85072NSTP	CHISEL	3/8	0.050	72	\$20.52
85084NSTP	CHISEL	3/8	0.050	84	\$23.88
85860NSTP	CHISEL	3/8	0.058	60	\$17.12
85868NSTP	CHISEL	3/8	0.058	68	\$19.29
85872NSTP	CHISEL	3/8	0.058	72	\$20.52
86366NSTP	CHISEL	3/8	0.063	66	\$18.78
86372NSTP	CHISEL	3/8	0.063	72	\$20.52
86384NSTP	CHISEL	3/8	0.063	84	\$23.88

PHONE (800) 569-2700



CHAINSAW BARS

TRILINK MINI LAMINATE SPROCKET NOSE BARS - have a rotating sprocket located at the tip of the bar with a single rivet construction.

PART #	PITCH	GAUGE	LNGTH	LINKS	RETAIL
M1431450-1074TP	3/8LP	0.043	14	50 DL	\$16.30
M1501244-1074TP	3/8LP	0.050	12	44 DL	\$15.10
M1501245-1041TP	3/8LP	0.050	12	45 DL	\$15.10
M1501450-1074TP	3/8LP	0.050	14	50 DL	\$16.30
M1501452-1041TP	3/8LP	0.050	14	52 DL	\$16.30
M1501452-1095TP	3/8LP	0.050	14	52 DL	\$16.30
M1501655-1074TP	3/8LP	0.050	16	55 DL	\$17.85
M1501656-1041TP	3/8LP	0.050	16	56 DL	\$17.85
M1501657-1041TP	3/8LP	0.050	16	56 DL	\$17.85
M1501862-1041TP	3/8LP	0.050	18	62 DL	\$22.80

TRILINK REPLACEABLE SPROCKET NOSE BARS - have a solid steel body with a replaceable sprocket nose tip. These bars are manufactured for high speed, heavy duty saws and are preferred by the profession and semi-professional cutter.

PART #	PITCH	GAUGE	LNGTH	LINKS	RETAIL
R2501872-11095TP	.325	0.050	18	72 DL	\$38.90
R2581666-11095TP	.325	0.058	16	66 DL	\$31.80
R3502072-4009TP	3/8	0.050	20	72 DL	\$43.25
R3581868-4009TP	3/8	0.058	18	68 DL	\$38.90
R3582072-4009TP	3/8	0.058	20	72 DL	\$43.25
R3502484-4009TP	3/8	0.050	24	84 DL	\$46.10
R3502892-4009TP	3/8	0.050	28	92 DL	\$58.85

CHAINSAW BARS



CHAINSAW

TRILINK LAMINATE SPROCKET NOSE BARS - have a rotating sprock located at the tip of the car with a sturdy four river construction. These are light bars that are typically used on consumer saws for the occasional or semi-professional user.

PART #	PITCH	GAUGE	LNGTH	LINKS	RETAIL
L1501245-1041TP	3/8LP	0.050	12	45 DL	\$15.10
L1501452-1041TP	3/8LP	0.050	14	52 DL	\$16.30
L1501656-1041TP	3/8LP	0.050	16	56 DL	\$17.85
L1501862-1041TP	3/8LP	0.050	18	62 LP	\$22.80
L2501666-11041TP	.325	0.050	16	60 DL	\$17.85
L2501872-11041TP	.325	0.050	18	72 DL	\$22.80
L2501872-11095TP	.325	0.050	18	72 DL	\$22.80
L2502078-11041TP	.325	0.050	20	78 DL	\$27.60
L2581666-11095TP	.325	0.058	16	68 DL	\$17.85
L2581872-11095TP	.325	0.058	18	72 DL	\$22.80
L2631662-1074TP	.325	0.063	16	672DL	\$17.85
L2631667-4025TP	.325	0.063	16	67 DL	\$17.85
L2631874-4025TP	.325	0.063	18	74 DL	\$22.80
L2632081-4025TP	.325	0.063	20	81 DL	\$27.60
L3501866-4025TP	3/8	0.050	18	66 DL	\$22.80
L3501866-4176TP	3/8	0.050	18	66 DL	\$22.80
L3501868-4009TP	3/8	0.050	18	68DL	\$22.80
L3502070-4176TP	3/8	0.050	20	70 DL	\$27.60
L3502072-11095TP	3/8	0.050	20	72 DL	\$27.60
L3502072-4009TP	3/8	0.050	20	72 DL	\$27.60
L3502072-4025TP	3/8	0.050	20	72 DL	\$27.60
L3581868-4009TP	3/8	0.058	18	68 DL	\$22.80
L3582072-4009TP	3/8	0.058	20	72 DL	\$27.60
L3631866-4025TP	3/8	0.063	18	66 DL	\$22.80
L3632072-4025TP	3/8	0.063	18	672DL	\$22.80

PHONE (800) 569-2700



**CALL FOR A COMPLETE
TRILINK CATALOG!**

CHAINSAW

CHAIN REPAIR KITS

PART #	CHAIN TYPE		RETAIL
143JK10TL	3/8"LP, .043"		\$3.83
150JK10TL	3/8"LP, .050"		\$3.83
250JK10TL	.325", .050"	EACH JOINING KIT CONTAINS 5 PRESETS AND 5 TIE STRAPS	\$3.83
258JK10TL	.325", .058"		\$3.83
263JK10TL	.325", .063"		\$3.83
350JK10TL	3/8", .050"		\$3.83
358JK10TL	3/8", .058"		\$3.83
363JK10TL	3/8", .063"		\$3.83
458JK10TL	.404", .058"		\$3.83
463JK10TL	.404", .063"		\$3.83

BAR NOSES - Single Rivet

PART #	DESCRIPTION	OREGON CROSS	RETAIL
RN25012	.325" .050" 12T	34775	\$10.16
RN25812	.325" .058" 12T	34775	\$10.16
RN26312	.325" .063" 12T	34775	\$10.16
RN35011	3/8" .050" 11T	30853	\$10.16
RN35811	3/8" .058 11T	30853	\$10.16
RN36311	3/8" .063 11T	30853	\$10.16
RN45810	.404" .058" 10t	30855	\$10.16
RN46310	.404" .063 10T	30855	\$10.16

RIM SPROCKETS

PART #	DESCRIPTION	CARLTON CROSS	RETAIL
R27M7	.325 7T MINI ID 0.665"		\$4.21
R27S7	.325 7T SMALL ID 0.775"	SR7-11892	\$4.21
R28S7	.325" 8T SMALL ID 0.775	SR8-11891	\$4.21
R37L7	3/8" 7T STD ID 0.886"	SR7-68210	\$4.21
R37M7	3/8" 7T MINI ID 0.652"		\$4.21
R37S7	3/8" 7T SMALL ID 0.775"	SR7-18720	\$4.21
R38L7	3/8" 8T STD ID 0.892"	SR8-22273	\$4.21
R47L7	.404 7T STD ID 0.870"	SR7-22270	\$4.21

orders@boettchersupply.com



SPROCKETS

PART #	DESCRIPTION	CARLTON CROSS	RETAIL
CHU400-L73N	CENTER DRIVE 3/8" 7T		\$20.66
CPA475-S27N	CENTER DRIVE .325" 7T		\$16.80
CST305-S27N	CENTER DRIVE .325"7T		\$16.80
CSAT328-L37N	CENTER DRIVE 3/8" 7T		\$22.64

SPUR SPROCKETS

PART #	DESCRIPTION	OREGON CROSS	RETAIL
SEC202-16N	3/8"LP 6T SPUR	106906X	\$17.22
SEC206-27N	.325" 7T SPUR	37509	\$16.28
SEC208-37N	3/8" 7T SPUR	21358X	\$15.30
SHO100-16N	3/8"LP 6T SPUR	27958	\$15.30
SHO110-16N	3/8"LP 6T SPUR	38010	\$16.28
SHO113-37N	3/8" 7T SPUR	30681X	\$17.22
SHO121-16N	3/8"LP 6T SPUR	108567	\$16.28
SHU414-27N	.325" 7T SPUR	108308X	\$16.28
SMC443-37N	3/8" 7T SPUR	32786X	\$18.19
SMC446-16N	3/8"LP 6T SPUR	29888	\$16.28
SPA475-16N	3/8"LP 6T SPUR	41569X	\$15.30
SPA475-27N	.325" 7T SPUR	41726X	\$16.28
SPO527-27N	3/8"LP 7T SPUR	107504X	\$18.19
SPO529-16N	3/8"LP 6T SPUR	28004	\$15.30
SPO531-37X	3/8" 7T SPUR	32790X	\$17.22
SPO532-16N	3/8"LP 6T SPUR	106114	\$15.30
SST305-16N	3/8"LP 6T SPUR	100962X	\$15.30
SST305-27N	.325" 7T SPUR	106657X	\$15.30
SST315-27N	.325" 7T SPUR		\$15.30
SST316-27N	.325" 7T SPUR	38145X	\$15.30
SST316-37N	3/8" 7T SPUR	38145X	\$15.30

PHONE (800) 569-2700



SAW CHAIN FILES

PART #	DESCRIPTION	RETAIL
DGFF001TL	Depth Guage & Flat File	\$5.01
FF001TL	Flat Files (Bulk) 12 per box	\$2.48
5322FTL2	5/32" Files - 2 per blister pack	\$5.01
3162FTL2	3/16" Files - 2 per blister pack	\$5.01
7322FTL2	7/32" Files - 2 per blister pack	\$5.01
532FBKTL	5/32" Round File (buk) 12 per box	\$1.65
316FBKTL	3/16" Round File (bulk) 12 per box	\$1.65
732FBKTL	7/32" Round File (bulk) 12 per box	\$1.65
532FGWTL	5/32" File & Guide - wooden handle	\$5.25
316FGWTL	3/16" File & Guide - wooden handle	\$5.25
732FGWTL	7/32" File & Guide - wooden handle	\$5.25
FK001TL	8 pc Sharpening Field Kit - (Kit includes: flat file, depth gauge, filing guide w/ thumbscrew, 1 of each file and wooden handle	\$18.75

SHARPENERS AND STONES

PART #	DESCRIPTION	RETAIL
ECS120ACTL	110V Sharpener, includes 72" JD power cord, chain angle guide and 1 each stone	\$41.25
ECS12DCTL	12V DC Sharpener, includes HD power battery connection cable, chain angle guide and 1 each stone	\$41.25
532SSTL	5/32" Sharpening stone - 3 per pack	\$ 3.20
316SSTL	3/16" Sharpening stone - 3 per pack	\$ 3.20
732SSTL	7/32" Sharpening stone - 3 per pack	\$ 3.20
BMS2000TL	Bar mounted sharpener, fits both triangle and flat depth gauge files	\$49.50



CHAIN BREAKER & SPINNER

PART #	DESCRIPTION	RETAIL
BK0001TL	Chain Breaker	\$ 74.25
SP001TL	Chain Spinner	\$ 74.25

MAINTENANCE

PART #	DESCRIPTION	RETAIL
PFW001TL	Poly Felling Wedge	\$ 7.37
TS-1319TL	13mm x 19mm Srench	\$ 2.68
LG001TL	Bar Lube Gun	\$10.05
FV001TL	Filing Vise	\$10.37
MK001PC2	Chain Multi-Tool - 13 tools in 1	\$27.69

SAFETY GEAR

PART #	DESCRIPTION	RETAIL
GV001TL	Chainsaw Safety Gloves - one size	\$ 24.87
PSH001TL	Helmet, Ear Muff & Face Shield	\$ 48.97
EF805B	Ear Muff Set	\$ 13.10
CPSXL500TL2	UL Certified & Approved Safety Chaps	\$111.31
CSB001TK	Chain Saw Case w/ Scabbard	\$ 59.03
BS001TL	20" Bar Scabbard	\$ 7.58



CSB001TK

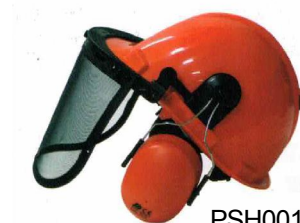

PSH001TL

PHONE (800) 569-2700



CHAINS

PART #	LENGTH	DESCRIPTION	GAUGE	RETAIL
N1C-25R	25 FT	3/8 Low Pro	.050	\$153.00
N1C-100R	100 FT	3/8 Low Pro	.050	579.00
N1C-BL-25R	25 FT	3/8 Low Pro Bumperlink	.050	153.00
N1C-BL-100R	100 FT	3/8 Low Pro Bumperlink	.050	579.00
N4C-25R	25 FT	3/8 Low Pro	.043	153.00
N4C-100R	100 FT	3/8 Low Pro	.043	579.00
N4C-BL-25R	25 FT	3/8 Low Pro Bumperlink	.043	153.00
N4C-BL-100R	100 FT	3/8 Low Pro Bumperlink	.043	579.00
A1EP-25R	25 FT	3/8 Semi- Chisel	.050	159.00
A1EP-100R	100 FT	3/8 Semi- Chisel	.050	602.00
A1EP-BL-25R	25 FT	3/8 Semi- Chisel Bumperlink	.050	159.00
A1EP-BL-100R	100 FT	3/8 Semi- Chisel Bumperlink	.050	602.00
A2EP-25R	25 FT	3/8 Semi- Chisel	.058	159.00
A2EP-100R	100 FT	3/8 Semi- Chisel	.058	602.00
A2EP-BL-25R	25 FT	3/8 Semi- Chisel Bumperlink	.058	159.00
A2EP-BL-100R	100 FT	3/8 Semi- Chisel Bumperlink	.058	602.00
A3EP-25R	25 FT	3/8 Semi- Chisel	.063	159.00
A3EP-100R	100 FT	3/8 Semi- Chisel	.063	602.00
A3EP-BL-25R	25 FT	3/8 Semi- Chisel Bumperlink	.063	159.00
A3EP-BL-100R	100 FT	3/8 Semi- Chisel Bumperlink	.063	602.00
A1LM-25R	25 FT	3/8 Magna- Chisel	.050	154.00
A1LM-100R	100 FT	3/8 Magna- Chisel	.050	584.00
A1LM-BL-25R	25 FT	3/8 Magna- Chisel Bumperlink	.050	154.00
A1LM-BL-100R	100 FT	3/8 Magna- Chisel Bumperlink	.050	584.00
A2LM-25R	25 FT	3/8 Magna- Chisel	.058	154.00
A2LM-100R	100 FT	3/8 Magna- Chisel	.058	584.00
A2LM-BL-25R	25 FT	3/8 Magna- Chisel Bumperlink	.058	154.00
A2LM-BL-100R	100 FT	3/8 Magna- Chisel Bumperlink	.058	584.00
A3LM-25R	25 FT	3/8 Magna- Chisel	.063	154.00
A3LM-100R	100 FT	3/8 Magna- Chisel	.063	584.00
A3LM-BL-25R	25 FT	3/8 Magna- Chisel Bumperlink	.063	154.00
A3LM-BL-100R	100 FT	3/8 Magna- Chisel Bumperlink	.063	584.00

orders@boettchersupply.com



CHAINS AW

PART #	LENGTH	DESCRIPTION	GAUGE	RETAIL
K1C-25R	25 FT	.325 Semi- Chisel	.050	\$ 167.00
K1C-100R	100 FT	.325 Semi- Chisel	.050	630.00
K1C-BL-25R	25 FT	.325 Semi- Chisel Bumperlink	.050	167.00
K1C-BL-100R	100 FT	.325 Semi- Chisel Bumperlink	.050	630.00
K2C-25R	25 FT	.325 Semi- Chisel	.058	167.00
K2C-100R	100 FT	.325 Semi- Chisel	.058	630.00
K2C-BL-25R	25 FT	.325 Semi- Chisel Bumperlink	.058	167.00
K2C-BL-100R	100 FT	.325 Semi- Chisel Bumperlink	.058	630.00
K3C-25R	25 FT	.325 Semi- Chisel	.063	167.00
K3C-100R	100 FT	.325 Semi- Chisel	.063	630.00
K3C-BL-25R	25 FT	.325 Semi- Chisel Bumperlink	.063	167.00
K3C-BL-100R	100 FT	.325 Semi- Chisel Bumperlink	.063	630.00
K1L-25R	25 FT	.325 Chisel	.050	167.00
K1L-100R	100 FT	.325 Chisel	.050	630.00
K1L-BL-25R	25 FT	.325 Chisel Bumper link	.050	167.00
K1L-BL-100R	100 FT	.325 Chisel Bumper link	.050	630.00
K2L-25R	25 FT	.325 Chisel	.058	167.00
K2L-100R	100 FT	.325 Chisel	.058	630.00
K2L-BL-25R	25 FT	.325 Chisel Bumper link	.058	167.00
K2L-BL-100R	100 FT	.325 Chisel Bumper link	.058	630.00
K3L-25R	25 FT	.325 Chisel	.063	167.00
K3L-100R	100 FT	.325 Chisel	.063	630.00
K3L-BL-25R	25 FT	.325 Chisel Bumper link	.063	167.00
K3L-BL-100R	100 FT	.325 Chisel Bumper link	.063	630.00
B3EP-25R	25 FT	.404 Semi- Chisel	.063	227.00
B3EP-100R	100 FT	.404 Semi- Chisel	.063	856.00
B3LM-100R	100 FT	.404 Magna- Chisel	.063	927.00
E1MC-BL-25R	25 FT	1/4" Semi- Chisel Bumperlink	.050	285.00
E1MC-BL-100R	100 FT	1/4" Semi- Chisel Bumperlink	.050	1075.00

FULL LINE CARLTON CATALOG AVAILABLE UPON REQUEST!

PHONE (800) 569-2700



**3/8 LP - .050 Gauge- Semi Chisel
BL - Bumperlink**

Part #	Retail
N1C-40-LP	\$14.45
N1C-44-LP	\$15.95
N1C-45-LP	\$16.30
N1C-50-LP	\$18.13
N1C-52-LP	\$18.85
N1C-55-LP	\$19.95
N1C-56-LP	\$20.25
N1C-57-LP	\$20.60
N1C-62-LP	\$22.50
N1C-BL-44-LP	\$15.80
N1C-BL-45-LP	\$16.20
N1C-BL-50-LP	\$18.00
N1C-BL-52-LP	\$18.75
N1C-BL-55-LP	\$19.80
N1C-BL-57-LP	\$20.50
N1C-BL-62-LP	\$22.35

**3/8 LP -.043 Gauge-Semi Chisel
BL - Bumperlink**

Part #	Retail
N4C-44-LP	\$15.95
N4C-50-LP	\$18.15
N4C-52-LP	\$19.00
N4C-55-LP	\$19.95

**3/8 -.050 Gauge - Full Chisel
GL - Guard Link**

Part #	Retail
A1LM-60-LP	\$22.50
A1LM-66-LP	\$24.75
A1LM-68-LP	\$25.50
A1LM-70-LP	\$26.30
A1LM-72-LP	\$27.00
A1LM-84-LP	\$31.55
A1LM-GL-66-LP	\$24.75
A1LM-GL-81-LP	\$26.30

3/8 .050 SKIP TOOTH

Part #	Retail
A1LMSK-72-LP	\$27.00

3/8 -.058 Gauge - Full Chisel

Part #	Retail
A2LM-60-LP	\$22.50
A2LM-68-LP	\$25.50
A2LM-72-LP	\$27.00
A2LM-84-LP	\$31.55

**3/8 -.063 Gauge - Full Chisel
GL - Guard Link**

Part #	Retail
A3LM-66-LP	\$24.75
A3LM-72-LP	\$27.00
A3LM-84-LP	\$31.55

**3/8 -.050 Gauge - Semi Chisel
GL - Guard Link**

Part #	Retail
A1EP-66-LP	\$26.45
A1EP-70-LP	\$28.10
A1EP-72-LP	\$28.85
A1EP-84-LP	\$33.65
A1EP-GL-60-LP	\$22.50

3/8 -.058 Gauge - Semi Chisel

Part #	Retail
A2EP-68-LP	\$27.25
A2EP-72-LP	\$28.85

3/8 -.063 Gauge - Semi Chisel

Part #	Retail
A3EP-66-LP	\$26.45
A3EP-72-LP	\$28.85



**.325 -.050 Gauge - Semi Chisel
BL - Bumperlink**

Part #	Retail
K1C-64-LP	\$23.15
K1C-66-LP	\$23.85
K1C-72-LP	\$26.10
K1C-78-LP	\$28.20
K1C-BL-78-LP	\$28.20

**.325 -.058 Gauge - Semi Chisel
BL - Bumperlink**

Part #	Retail
K2C-66-LP	\$23.85
K2C-72-LP	\$26.10

**.325 -.063 Gauge - Semi Chisel
BL - Bumperlink**

Part #	Retail
K3C-62-LP	\$22.40
K3C-67-LP	\$24.20
K3C-74-LP	\$26.75
K3C-81-LP	\$29.30
K3C-BL-81-LP	\$29.30

**.325 -.050 Gauge - Full Chisel
BL - Bumperlink**

Part #	Retail
K1L-64-LP	\$23.15
K1L-66-LP	\$23.85
K1L-67-LP	\$24.20
K1L-72-LP	\$26.10
K1L-78-LP	\$28.20

.325 -.058 Gauge - Full Chisel

Part #	Retail
K2L-64-LP	\$23.15
K2L-66-LP	\$23.85
K2L-72-LP	\$26.10

**.325 -.063 Gauge - Full Chisel
BL - Bumperlink**

Part #	Retail
K3L-67-LP	\$24.20
K3L-68-LP	\$24.60
K3L-74-LP	\$26.75
K3L-81-LP	\$29.30



**Loops not listed can be made to your specifications.
Call for quote on any length chain.**



SAW CHAIN CONVERSION TABLE

CHAINS	CARLTON	DESCRIPTION	PITCH	GAUGE	TRLINK	OREGON	STIHL
	E1MC	Micro Chisel Chain	1/4"	.050"	----	----	----
	E1MC-BL	Micro Chisel Bumper Link	1/4"	.050"	----	25AP,A,F	13RM
	K1L	Chisel Chain	.325"	.050"	750	20LPX	23RS
	K2L	Chisel Chain	.325"	.058"	758	21LPX	25RS
	K3L	Chisel Chain	.325"	.063"	763	22LPX	26RS
	K1L-BL	Chisel Chain Bumper Link	.325"	.050"	----	20LP/33SL	23RM2
	K2L-BL	Chisel Chain Bumper Link	.325"	.058"	----	21LP/34SL	25RM2
	K3L-BL	Chisel Chain Bumper Link	.325"	.063"	----	22LP/35SL	26RM2
	K1NK	Narrow Kerf Semi-Chisel	.325"	.050"	----	----	
	K1NK-BL	NK Semi-Chisel Bumper Link	.325"	.050"	----	95VP	23RM
	K1C	Semi-Chisel Chain	.325"	.050"	250	20BPX	----
	K2C	Semi-Chisel Chain	.325"	.058"	258	21BPX	----
	K3C	Semi-Chisel Chain	.325"	.063"	263	22BPX	----
	K1C-BL	Semi-Chisel Chain Bumper Link	.325"	.050"	----	20BPX	23RM2
	K2C-BL	Semi-Chisel Chain Bumper Link	.325"	.058"	----	21BPX	25RM2
	K3C-BL	Semi-Chisel Chain Bumper Link	.325"	.063"	----	22BPX	26RM2
	N4C	Narrow Kerf Semi-Chisel Chain	3/8"LP	.043"	----	61PMN	
	N4C-BL	NK Semi-Chisel Bumper Link	3/8"LP	.043"	----	90SG, PX	61PMMC3
	N1C	Semi-Chisel Chain	3/8"LP	.050"	150	91P,S,PX	63PM
	--n/a--	Full Chisel Chain	3/8"LP	.050"	650	----	----
	N1C-BL	Semi-Chisel Bumper Link	3/8LP	.050"	----	91P,PS,PX	63PMC3
	A1LM	Chisel Chain	3/8"	.050"	850	72LGX	33RS
	A2LM	Chisel Chain	3/8"	.058"	858	73LGX	35RS
	A3LM	Chisel Chain	3/8"	.063"	863	75LGX	36RS
	A1LM-BL	Chisel Chain Bumper Link	3/8"	.050"	----	72LP, V	33RS
	A2LM-BL	Chisel Chain Bumper Link	3/8"	.058"	----	73LP, V	35RS
	A3LM-BL	Chisel Chain Bumper Link	3/8"	.063"	----	75LP, V	36RS
	A1EP	Semi-Chisel Chain	3/8"	.050"	350	72DPX	33RM
	A2EP	Semi-Chisel Chain	3/8"	.058"	358	73DPX	35RM
	A3EP	Semi-Chisel Chain	3/8"	.063"	363	75DPX	36RM
	A1EP-BL	Semi-Chisel Bumper Link	3/8"	.050"	----	72DP	33RM
	A2EP-BL	Semi-Chisel Bumper Link	3/8"	.058"	----	73DP	35RM
	A3EP-BL	Semi-Chisel Bumper Link	3/8"	.063"	----	75DP	36RM
	B2LM	Chisel Chain	.404"	.058"	----	58L	45RS
	B3LM	Chisel Chain	.404"	.063"	----	59L	46RS
	B2EP	Semi-Chisel Chain	.404"	.058"	----	26X	45RM
	B3EP	Semi-Chisel Chain	.404"	.063"	----	27X	46RM

orders@boettchersupply.com



CHAINS AW

CARLTON CHAIN	DRIVE LINK	TIE STRAP	PRESET KIT	R.H. CUTTER	L.H. CUTTER	REPAIR KIT
A1EP	552354	43003	43012	43074	43075	552359
A2EP	552355	43003	43012	43074	43075	552360
A3EP	552356	43003	43013	43074	43075	552226
A1EP-BL	552354	43003	43012	43074	43075	----
A2EP-BL	552355	43003	43012	43074	43075	----
A3EP-BL	552356	43003	43013	43074	43075	----
A1LM	552354	43003	43012	43191	43190	552359
A2LM	552355	43003	43012	43191	43190	552360
A3LM	552356	43003	43013	43191	43190	552226
B2EP	----	43004	43015	43066	43086	41113
B3EP	43111	43004	43015	43066	43086	41114
B2LM	----	43004	43015	43300	43301	41113
B3LM	43111	43004	43015	43300	43301	41114
E1MC-BL	43113	43044	43045	43046	43047	41112
K1C	43100	43000	43008	43070	43071	41100
K2C	43101	43000	43008	43070	43071	41101
K3C	43102	43000	43009	43070	43071	41102
K1C-BL	43100	43000	43008	43070	43071	41122
K2C-BL	43101	43000	43008	43070	43071	41123
K3C-BL	43102	43000	43009	43070	43071	41124
K1L	43100	43000	43008	43060	43061	41100
K2L	43101	43000	43008	43060	43061	41101
K3L	43102	43000	43009	43060	43061	41102
N1C	43105	43002	43011	43063	43064	41105
N1C-BL	43105	43002	43011	43063	43064	41104
N4C	43122	43002	42993	43063	43063	----
N4C-BL	43122	43002	42993	43064	43064	----

REPLACEMENT CHAIN PARTS	
<i>(AVAILABLE IN PACKAGES OF 25)</i>	
PART	RETAIL
DRIVE LINKS	\$10.85
TIE STRAPS	\$10.85
PRE-SET TIE STRAPS	\$18.40
CUTTERS	\$45.30
REPAIR KITS	\$ 5.62

PHONE (800) 569-2700



Maintenance Tools

Part #	Description	Retail
*78015	Handheld 12V Chainsaw Sharpener	\$30.25
*78030	Tough Black Plastic Scabbard 10-14"	\$ 3.00
*24C1000	Portable Steel Stump Vise	\$23.00
*54C1010	High Quality Cowhide Protective Gloves Large	\$18.94
*32C1100	Felling Wedge 10"	\$ 7.35
*32C1080	Felling Wedge 8"	\$ 6.45
*41C1319T	Scrench 13 x 19 x 68	\$ 3.25
*41C1719	Scrench 17 x 19 x 68	\$ 3.25



**Limited Availability - please check before ordering.*

Sharpening Accessories

Part #	Description	Retail
*22C2000	Bar Mounted Sharpener Precise and easy, holds round and flat files	\$29.70
*23C4525	Sharpening Kit** - 11/64"	\$15.25
*23C4825	Sharpening Kit** - 3/16"	\$15.25
*23C4025	Sharpening Kit** - 5/32"	\$15.25
*23C5525	Sharpening Kit** - 7/32"	\$15.25

**Kits contain 2 plastic File handles, 1 Round File, 1 Flat File, 1 File Holder and 1 Depth Gauge Tool



Power Drive Sprockets

PART #	PITCH	# TEETH	RETAIL
6-100791X	.325	7	\$28.73
6-100961X	.325	7	\$28.73
6-29175X	.325	7	\$28.73
6-105772X	3/8	7	\$28.73
6-28094X	3/8	7	\$28.73
6-34162X	3/8	7	\$28.73

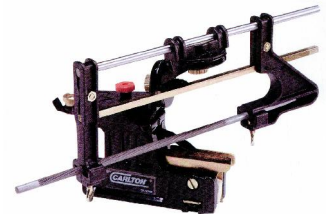



CHAINSAW

Chain Saw Files (Boxed in packages of 12, priced individually)		
Part #	Description	Retail
20C0616	6" Flat File	\$4.45
21C1840	5/32" Round for 3/8LP Chain	\$1.85
21C0845 (75080)	11/64" Round for .325 Chisel Chain	\$1.85
21C1848	3/16" Round for .325 Semi Chisel Chain	\$1.85
21C0852 (75090)	13/64" Round File for 3/8" Chain	\$1.85
21C1855 (75060)	7/32" Round for 3/8" & .404" Chain	\$1.85
29C2000	File Handle	\$2.50

Mini - 5/8" ID ~~~ Small - 3/4" ID ~~~ Standard - 7/8" ID

Chain Saw Rim Sprockets				
Part #	Pitch	MFG #	Description	Retail
36-1688	3/8"LP		7 tooth small, 7 spline	\$6.89
36-1689	3/8"		7 tooth standard, 7 spline	\$6.89
36-9498	3/8"		8 tooth standard, 7 spline	\$6.95
36-10987	3/8"		7 tooth mini, 7 spline	\$6.75
36-12582	3/8"	RST-375-8	8 tooth standard, 7 spline	\$5.50
36-12584	3/8"	RST-375-7	7 tooth standard, 7 spline	\$5.50
36-12585	3/8"	RMI-375-7	7 tooth standard, 7 spline	\$5.50
36-12588	3/8"	RSM-375-7	7 tooth small, 7 spline	\$5.50
36-1690	.325"		7 tooth small, 7 spline	\$6.89
36-9499	.325"		8 tooth small, 7 spline	\$6.95
36-10986	.325"		7 tooth mini, 7 spline	\$6.75
36-12586	.325"	RMS-325-8	8 tooth mini, 7 spline	\$5.50
36-12587	.325"	RMI-325-7	7 tooth mini, 7 spline	\$5.50
36-12589	.325"	RSM-325-7	7 tooth small, 7 spline	\$5.50
36-12591	.325"	RST-325-9	9 tooth standard, 7 spline	\$5.50
36-12590	.404"	RST-404-8	8 tooth standard, 7 spline	\$7.00
36-1686	.404"		7 tooth standard, 7 spline	\$6.89
36-12583	.404"	RST-404-7	7 tooth standard, 7 spline	\$5.50
36-12592	1/4"	RSM-250-9	9 tooth standard, 7 spline	\$5.50

PHONE (800) 569-2700

Complete Grinder Part #12C1115 Retail - \$430.00

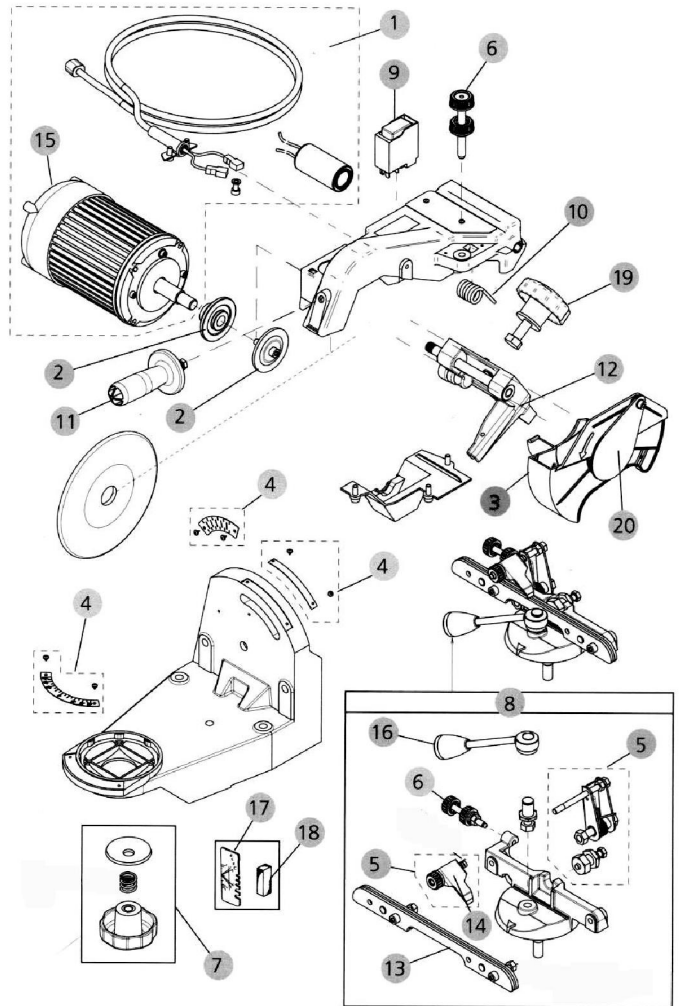

Replacement parts for 12C1115 Grinder

Ref.	Part #	Description	Retail
	13C1060	Grinding Wheel 5-3/4" for 1/2" & Depth	\$ 36.37
	13C1047	Grinding Wheel 5-3/4" for 3/8" Std, .404	\$ 36.37
	13C1032	Grinding Wheel 5-3/4" for 1/4", 3/8LP, .325"	\$ 33.20
1.	537398	Electrical Assembly Complete	\$292.36
3.	522692	Shield Kit	\$ 33.35
5.	522688	Chain Stop Assembly Kit	\$ 12.69
6.	537412	Adjustable knob	\$ 11.12
7.	537413	Vice Adjustment Knob Kit	\$ 17.37
8.	534477	Vice Assy w/ no down angle	\$126.04
9.	109879	Switch on/off	\$ 94.33
10.	35589	Spring arm return	\$ 6.77
11.	105538	Handle Kit, head assy	\$ 19.88
12.	522649	Bracket arm support	\$ 70.10
13.	534549	Vice Jaws assembly	\$ 35.70
14.	32677	Chain Stop single - (package of 5)	\$ 38.87
15.	37947	End motor cap	\$ 10.85
16.	534550	Vise Handle Kit	\$ 28.22
17.	35596	Wheel Contour Template	\$ 5.20
18.	DB-2	Dressing Brick	\$ 12.87
19.	109246	Knob (short) and bolt	\$ 14.45

Bench Breaker #10C1000

RETAIL - \$142.00

Replacement Parts		
Part #	Description	Retail
38595	Cap	\$ 2.17
38593	Spring	\$ 4.80
38592	Handle	\$16.65
109644	Punch .043	\$10.60
38594	Standard Punch	\$ 7.83
111939	Anvil	\$29.30
105530	Anvil	\$34.00

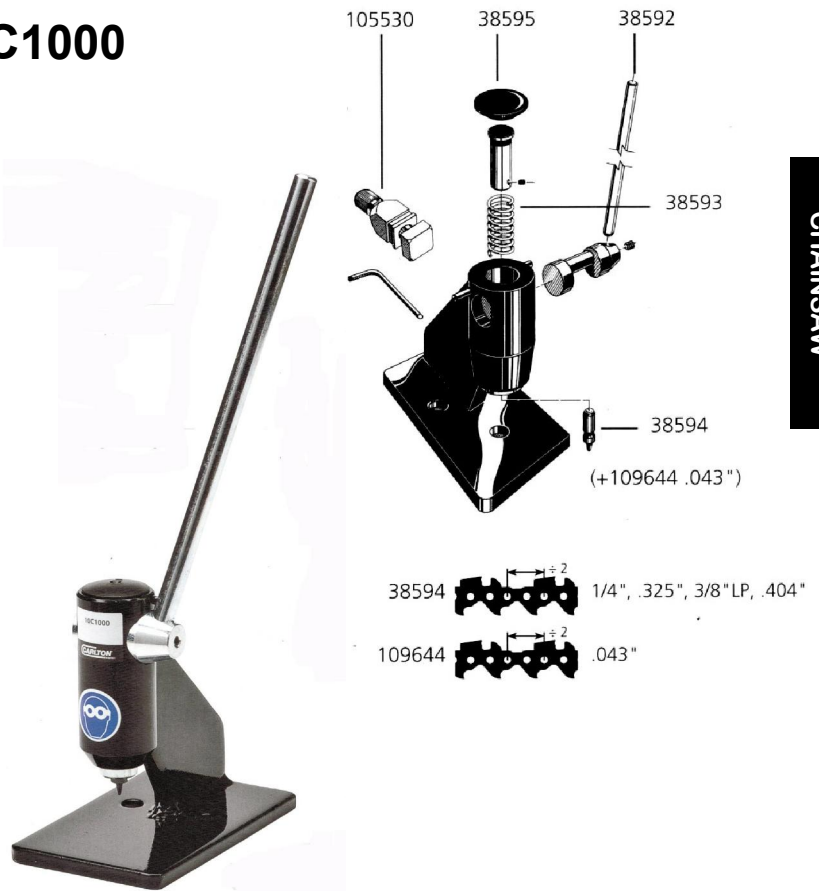

CHAINSAW



CARLTON
SAW CHAIN

Rivet Spinner #11C1000

RETAIL - \$142.00

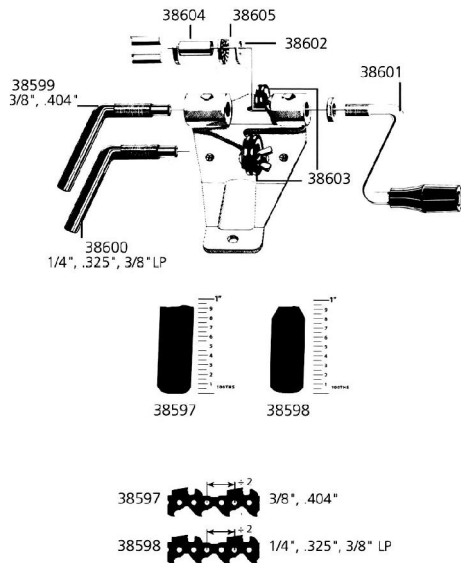

Replacement Parts		
Part #	Description	Retail
38601	Handle w/ Grip	\$31.05
38602	Shim	\$ 3.50
38605	Thrust Bearing	\$15.52
38604	Sleeve	\$40.02
38597	"A" Anvil, 3/8" & .404	\$ 7.83
38598	"B" Anvil, 1/4,325,3/8LP	\$ 8.38
38599	A Take Up Handle	\$24.30
38600	B Take Up Handle	\$24.30
38603	Chain Support Disk	\$ 6.25

PHONE (800) 569-2700



CHAINS AW BARS

LIMITED STOCK ON SOME BARS - PLEASE CHECK AVAILABILITY

CHAINS AW

PART #	DESCRIPTION	LGTH	PITCH	GAUGE	RETAIL
12-01-N1-MHC	Mini Hobby Champ - Laminated Sprocket	12	3/8LP	.050	\$13.47
1203050PH	Premium Hard - Solid Steel Hard Nose	12	3/8LP	.050	\$39.45
12-26-N1-MHC	Mini Hobby Champ - Laminated Sprocket	12	3/8LP	.050	\$13.47
12-29-N1MHC	Mini Hobby Champ - Laminated Sprocket	12	3/8LP	.050	\$14.14
14-01-N152PT	Semi-Pro - Laminated Larger Sprocket Nose	14	3/8LP	.050	\$36.97
14-01-N152RK	Safe Tip - Laminated Narrow Sprocket Nose	14	3/8LP	.050	\$36.04
14-01-N1MHC	Mini Hobby Champ - Laminated Sprocket	14	3/8LP	.050	\$14.59
1403050PH	Premium Hard - Solid Steel Hard Nose	14	3/8LP	.050	\$40.55
14-10-N152PT	Semi-Pro - Laminated Larger Sprocket Nose	14	3/8LP	.050	\$36.97
14-10-N152RK	Safe Tip - Laminated Narrow Sprocket Nose	14	3/8LP	.050	\$36.04
14-10-N4MHC	Mini Hobby Champ - Laminated Sprocket	14	3/8LP	.050	\$13.88
14-12-N153PML	Premium Mini Laminate - Repl.. Sprocket	14	3/8LP	.050	\$16.67
14-26-N150PT	Semi-Pro - Laminated Larger Sprocket Nose	14	3/8LP	.050	\$36.97
14-26-N150RK	Safe Tip - Laminated Narrow Sprocket Nose	14	3/8LP	.050	\$36.04
14-26-N1-MHC	Mini Hobby Champ - Laminated Sprocket	14	3/8LP	.050	\$13.90
15-42-K363TC	Timber Champ - Laminated Sprocket	15	.325	.063	\$28.51
16-01-N156PT	Semi-Pro - Laminated Larger Sprocket Nose	16	3/8LP	.050	\$38.10
16-01W-K166SP	Super Pro - Laminated Sprocket	16	.325	.050	\$64.26
1603N157PML	Premium Mini Laminate - Repl.. Sprocket	16	3/8LP	.050	\$17.22
16-10-N156RK	Safe Tip - Laminated Narrow Sprocket Nose	16	3/8LP	.050	\$39.80
16-10-N157PT	Semi-Pro - Laminated Larger Sprocket Nose	16	3/8LP	.050	\$38.10
16-24-K168TC	Timber Champ - Laminated Sprocket	16	.325	.050	\$27.95
16-25-N159FC	Forest Champ - Replaceable Sprocket	16	3/8LP	.050	\$32.67
16-26-K362SP	Super Pro - Laminated Sprocket	16	.325	.063	\$36.57
16-26-N155PT	Semi-Pro - Laminated Larger Sprocket Nose	16	3/8LP	.050	\$40.69
16-26-N155RK	Safe Tip - Laminated Narrow Sprocket Nose	16	3/8LP	.050	\$39.80
16-27-A160PC	Pro-Champ - Pro Replaceable Sprocket	16	3/8	.050	\$37.67
1631050PH	Premium Hard - Solid Steel Hard Nose	16	.325 - 3/8	.050	\$63.50
16-42-063DT	Dura Tip - Hard Tip Nose	16	.325 - 3/8	.063	\$72.06
16-42-A160SP	Super Pro - Laminated Sprocket	16	3/8	.050	\$65.46
16-42-A360PT	Semi-Pro - Laminated Larger Sprocket Nose	16	3/8	.063	\$40.69
16-42-K167TC	Timber Champ - Laminated Sprocket	16	.325	.050	\$27.95
16-42-K367PT	Semi-Pro - Laminated Larger Sprocket Nose	16	.325	.063	\$40.69
16-71-A160PC	Pro-Champ - Pro Replaceable Sprocket	16	3/8	.050	\$37.67
16-81-050BC	Bush Champ - Solid Hard Nose	16	.325 - 3/8	.050	\$40.88
16-81-A160PS	Premium Sprt - Solid w/ Repl Sprocket	16	3/8	.050	\$48.00
16-81-A160TC	Timber Champ - Laminated Sprocket	16	3/8	.050	\$27.95
16-81-A260ST	Speed Tip - Laminated Repl. Sprocket	16	3/8	.058	\$94.05
16D025A1PS	Premium Sprt - Solid w/ Repl Sprocket	16	3/8	.050	\$48.00

FAX (800) 489-4804



CHAINS AW BARS

LIMITED STOCK ON SOME BARS - PLEASE CHECK AVAILABILITY

PART #	DESCRIPTION	LGTH	PITCH	GAUGE	RETAIL
18-01-K172TC	Timber Champ - Laminated Sprocket	18	.325	.050	\$25.45
18-01W-A264PS	Premium Sprt - Solid w/ Repl Sprocket	18	3/8	.058	\$46.66
18-01W-K272TC	Timber Champ - Laminated Sprocket	18	.325	.058	\$27.20
18-01W-K272TC12	Timber Champ - Laminated Sprocket	18	.325	.058	\$27.20
18-09-K272TC	Timber Champ - Laminated Sprocket	18	.325	.058	\$30.07
18-10-N162RK	Safe Tip - Laminated Narrow Sprocket Nose	18	3/8LP	.050	\$43.83
18-10W-K272PT	Semi-Pro - Laminated Larger Sprocket Nose	18	.325	.058	\$40.44
18-42-A366SP	Super Pro - Laminated Sprocket	18	3/8	.063	\$52.73
18-42-K174TC	Timber Champ - Laminated Sprocket	18	.325	.050	\$30.10
18-42-K174TC12	Timber Champ - Laminated Sprocket	18	.325	.050	\$34.19
18-42-K374PT	Semi-Pro - Laminated Larger Sprocket Nose	18	.325	.063	\$51.20
18-71-A268SP	Super Pro - Laminated Sprocket	18	3/8	.058	\$54.36
18-81-A268PC	Pro-Champ - Pro Replaceable Sprocket	18	3/8	.058	\$40.55
18-81-A268PS	Premium Sprt - Solid w/ Repl Sprocket	18	3/8	.058	\$46.66
2005050PH	Premium Hard - Solid Steel Hard Nose	20	3/8	.050	\$69.85
2031063PH	Premium Hard - Solid Steel Hard Nose	20	.325 - 3/8	.063	\$69.85
20-42-A372PT	Semi-Pro - Laminated Larger Sprocket Nose	20	3/8	.063	\$54.88
20-42-A372SP	Super Pro - Laminated Sprocket	20	3/8	.063	\$55.97
20-42-A372ST	Speed Tip - Laminated Repl. Sprocket	20	3/8	.063	\$90.88
20-42-K181TC	Timber Champ - Laminated Sprocket	20	.325	.050	\$34.53
20-42-K381SP	Super Pro - Laminated Sprocket	20	.325	.063	\$55.97
20-42-K381ST	Speed Tip - Laminated Repl. Sprocket	20	.325	.063	\$52.25
20-81-A172ST	Speed Tip - Laminated Repl. Sprocket	20	3/8	.050	\$63.54
20-81-A272PT	Semi-Pro - Laminated Larger Sprocket Nose	20	3/8	.058	\$56.55
20D025063PH	Premium Hard - Solid Steel Hard Nose	20	3/8	.063	\$73.28
20K095A1PS	Premium Sprt - Solid w/ Repl Sprocket	20	3/8	.050	\$50.12
24-42-063DT	Dura Tip - Hard Tip Nose	24	.325 - 3/8	.063	\$94.21
24-81-A184ST	Speed Tip - Laminated Repl. Sprocket	24	3/8	.050	\$85.72
24-81-A284ST	Speed Tip - Laminated Repl. Sprocket	24	3/8	.058	\$85.72
24D025A1PS	Premium Sprt - Solid w/ Repl Sprocket	24	3/8	.050	\$52.63
28-42-A391ST	Speed Tip - Laminated Repl. Sprocket	28	3/8	.063	\$98.70
28-81-A192ST	Speed Tip - Laminated Repl. Sprocket	28	3/8	.050	\$98.70

CHAINS AW

SPROCKET NOSE REPLACEMENTS ~ LIMITED AVAILABILITY				
PART #	FITS	PITCH	# TEETH	RETAIL
STA325	Speed Tip	.325	12	\$25.45
STA375	Speed Tip	3/8	11	\$25.45
PST325	Sprocket Tip	.325	12	\$25.45
PST375	Sprocket Tip	3/8	11	\$25.45



PHONE (800) 569-2700

LASER

CHAINSAW

PART #	DESCRIPTION	RETAIL
AIR FILTERS		
93136	Briggs & Stratton 698754/499486 (Intek 14-24)	\$ 8.03
93148	Kohler #12-083-10, CV11-14	\$ 11.67
93011	Honda 17210ZE1821 GX110, 120, 140, 160	\$ 8.51
OIL FILTERS		
93100	Kawasaki #49065-7010 (smaller version)	\$ 5.34
SPARK PLUG		
30168	Spark Plug J19LM replacement	\$ 1.93
BELTS		
95184	AYP Deck Belt 144200	\$ 12.63
95210	MTD Belt 954-0371A	\$ 28.93
95622	MTD belt 954-0439	\$ 26.41
CHAINSAW -- SAFETY GEAR		
22700	Guardsman Head Set, Helmet w/ visor, ear muffs	\$ 31.38
47008	Safety Ear Muff set	\$ 10.85
47037	Grease Gun	\$ 14.10
47981	Foam ear plugs - bucket of 50	\$ 19.21
42936	Tree Blaster Cone Wedge	\$ 16.40



#93011



#93082



#22700



#42936

TWIST-N-TRIM QUICK LOADING TRIMMER HEADS

- * Head can be loaded **WITHOUT** taking apart and winding spools
- * Bump Feed system dispenses line quickly & easily
- * Ideal for Landscapers & Homeowners



PART #	DESCRIPTION	RETAIL
42675	8mm X 1.25 LH - Male/Female	\$ 8.03
42676	10mm x 1.25 LH - Male/Female	\$ 11.67

LASER

CHAINSAW

Chain Breaker

The 47003 Chain Breaker is a rugged time saving tool that offers effortless rivet punching for all chain sizes, 1/4" to 1/2" pitch.

PART # 47003

RETAIL \$83.10



CHAINSAW FILES - Vallorbe

PART #	DESCRIPTION
47406	5/32" Chainsaw Files (12)
47407	3/16" Chainsaw Files (12)
47408	7/32" Chainsaw Files (12)

RETAIL \$1.54



Chain Spinner

The 47004 Rivet Spinner is a time saving tool that is rugged and built to last! Offers professional rivet spinning for all chain sizes 1/4" to 1/2" pitch.

PART # 47004

RETAIL \$67.99



CARBURETOR ADJUSTMENT TOOLS

Set of eight popular carburetor adjusting tools - with carrying case

PART # 48025

RETAIL \$20.07

CYLINDER ASSEMBLIES

(Includes Cylinder, Rings, Piston)

More available, call for more options

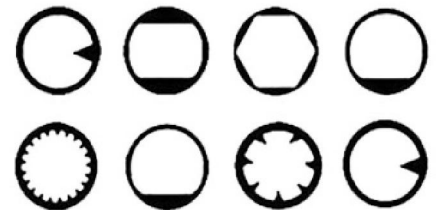

PART #	DESCRIPTION	RETAIL
44106	Fits Stihl MS200/020 40mm	\$ 66.97
44113	Fits Stihl 036/MS360	\$ 57.40
44331	Fits Stihl 046/MS460	\$ 76.53
44332	Fits Stihl 066/MS660	\$ 52.63
44351	Fits Stihl 025/MS250	\$ 43.06
44916	Fits Stihl 029/MS290	\$ 52.63
44967	Fits Stihl 026/MS260	\$ 62.18
44117	Fits Husqvarna 455 47mm	\$ 71.75
44229	Fits Husqvarna 61	\$ 47.83
44342	Fits Husqvarna 55	\$ 52.63
44343	Fits Husqvarna 350	\$ 43.06
44344	Fits Husqvarna 345	\$ 57.40
44348	Fits Husqvarna 359	\$119.59



PRICES GOOD WHILE SUPPLIES LAST

PHONE (800) 569-2700

The Top Saw Pocket Tool! - "Keep your saw in Tip Top Shape"



Bar Groove Clean Out Tool
For bar maintenance and cleaning

Large Screwdriver
For bar adjustment

T27 Torx
For Stihl, Dolmar, Makita and others

Small Screwdriver
For fuel and bar oil adjustment



4mm Wrench
For Husqvarna, Jonsered, Poulan, Partner and others

19mm Deep Socket
fits Stihl bar nuts and spark plugs on almost all other saws. Available with reversible 19 and 10 mm socket or 19 and 16mm socket

13mm (1/2") Socket
Fits bar nuts on most saws and can be used as a file handle

PART #	DESCRIPTION	RETAIL
A1619	Top Saw with Sheath 16mm x 19mm For Husqvarna, Stihl, Dolmar and any models with 16mm bar nuts.	\$19.99
B1910	Top Saw with Sheath 19mm x 10mm For Echo, Tanaka and any models with 10mm bar nuts	\$19.99

SUPER LUBE Bar & Chain Oil

100% Virgin Oil - High Tac - No Sling - Reduces Throw Off, Increases Chain Life

GALLON JUGS - SLG
4 PER CASE



QUART BOTTLES - SLQ
12 PER CASE

CALL FOR PRICING ON LARGER QUANTITIES!

GALLON JUGS - LLG
4 PER CASE
WINTER GRADE

****Bar Oil does not qualify for free freight**

FAX (800) 489-4804



**CALL FOR
A COMPLETE
CATALOG**

ROTARY

Assortments & Refills

Throttle & Brake Controls

Go-Kart Accessories

Drive Parts, gears, rollers, etc

Wheels, steel & plastic

Tires, Tubes, & Hubs



Bearings & Bushings

Deck & Wheel parts

Roller Chain & Links

Belts, premium and oem

Pulleys, V-Pulleys, Flat Idlers

Lawnmower & Edger Blades

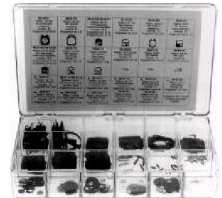

Blade Adapters

Air, Oil & Fuel Filters

Fuel Line & Accessories

Seats & Seat Covers

Small Engine parts - carb kits

Spark Plugs & Accessories



Starter Rope & Handles

Starter - Electric, Recoil & parts

Trimmer Line & Brushcutter blades

Grass Catcher Bags

Chainsaw Bars, Sprockets, Accessories

ATV, Snowblower & Pressure Washer Parts

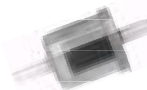

PHONE (800) 569-2700



****PRICES SUBJECT TO CHANGE!!****

ROTARY

PART #	DESCRIPTION	RETAIL
01-16129	Pivot Point Bow-Tie Locking Cotter Asst contains 80 assorted pieces 1/4" to 3/4"	\$ 25.50
03-13746	Scag Throttle Cable 54-1/2" lngth Scag #48946	\$ 23.80
03-13745	Honda Clutch Drive Cable 54630-VF0-952	\$ 11.39
08-16244	QuikStem QX-340 push in valve stem. Fits .453 hole	\$ 12.80
08-15559	Kenda TL Super Turf tire 13 x 500 x 6 4 ply	\$ 44.98
08-16277	Kenda TL Turf Rider tire 13 x 500 x 6 2 ply	\$ 32.80
10-16084	Bad Boy Spindle 037-6015-50. Fits Outlaw XP	\$199.95
10-15873	Cub Cadet Spindle 918-06978. Fits RZT & XT1	\$ 78.42
10-16024	Husqvarna Spindle 58165051 581650801 42"	\$ 45.99
10-16121	MTD/Troybilt Steering Shaft 738-0919, 938-0919	\$ 33.08
10-16123	MTD/Cub Cadet Steering Gear 917-1550E	\$ 41.38
10-16139	MTD/Troybilt Steering Gear 617-04094	\$ 16.44
10-16035	Husqvarna Electric Clutch 532198143	\$251.99
10-15210	John Deere Electric Clutch GY20878,GY20108	\$244.70
10-16133	Toro/Exmark Electric Clutch 110-6766 Timecutter	\$358.99
12-15556	Cub Cadet belt 954-04325 1/2" x 125" 46" RZT mower	\$ 52.50
12-12455	Exmark 109-3661, Engine to Deck belt 1/2" x 154"	\$ 61.02
12-16093	John Deere M127926 timing belt LT133,155,166	\$ 74.39
12-14317	Toro 133-1166, 117-7325 Deck belt Titan 48"	\$ 93.28
13-15554	Hustler 603986, Flat idler pulley for Raptor 42"	\$ 15.71
13-15911	John Deere M170230, Deck spindle pulley	\$ 11.16
13-16272	Snapper 7023954, Flat Idler transmission drive pulley	\$ 16.80

**LOTS MORE AVAILABLE, CHECK OUT
THE NEW 2020 ROTARY CATALOG!!**

orders@boettchersupply.com



****PRICES SUBJECT TO CHANGE!!****

PART #	DESCRIPTION	RETAIL
15-13817	Country Clipper H-1665, blade for 42" mower 1/2" bore	\$ 13.95
15-13818	Country Clipper H-2246, blade for 52" mower 1/2" bore	\$ 15.95
15-16235	Husqvarna 532134148,532139774 Mulcher, 19-5/16"	\$ 14.99
15-14679	Husqvarna 573953001 Mulcher Blade, 14-5/8, 5 pt star	\$ 22.99
15-13805	John Deere M136195 blade Hvy Duty, 19" x .904"	\$ 21.40
15-13136	John Deere M170639, GY20683 blade, 21-3/8" x .800"	\$ 25.87
15-13808	John Deere TCU15882 Mulcher blade, 25" x .900"	\$ 24.04
15-13815	Murray 95104E701 Mulcher blade, 19-1/2" x .850"	\$ 19.80
15-15112	Toro 115-4999-03 Mulcher blade, 18-3/4" x 5/8"	\$ 20.45
19-16109	Kohler Air Filter 32-083-12, KT and EKT series	\$ 24.97
19-16004	Briggs Bulk pack of 25 - 19-14364 - B&S 593260 (\$4.50 each in bulk pack, 19-14364 - \$5.23 singles)	\$266.25
20-14816	Briggs Primer Bulb 594281, 450E/500 models	\$ 4.00
20-188-570-1	Walbro Ethanol Resistant version of 188-512-1	\$ 6.60
20-16228	Echo Fuel Tank Vent A356000031, Stihl 1129-350-5850	\$ 5.72
23-13648	Briggs Cylinder Head gasket 796584	\$ 15.40
26-15525	Honda Recoil Starter 28400Z0M801, fro GCV135/160/190	\$ 18.00
31-16148	Briggs Ignition Coil 590455, model 122000 engines	\$ 51.00
31-16151	Briggs Ignition Coil 590454, 122 series w/ auto choke	\$ 45.80
31-16145	Honda Ignition Coil 30550ZJ1845 for GX610/620/670	\$ 66.70
31-16147	Honda Ignition Coil 30500ZJ1845 for GX610/620/670	\$ 66.70
32-16263	Belt Guage Extender - adds 40" length to 32-9108	\$ 69.00
33-16217	Athena GET Jumpstarter for gass engines	\$ 99.95
39-16195	Echo Oil Pump 43700239130 for 340/341/3000 saws	\$ 52.12
39-16197	Echo/Shindaiwa Auto Oiler pump C0220000020	\$ 42.47

ROTARY

PHONE (800) 569-2700



COMPLETE CARBURETORS

Many more available in full line catalog

****PRICES SUBJECT TO CHANGE!!****

ROTARY

22-13192

Honda Replacement Carburetor
Part #16100-ZH7-W51
Fits models GX120

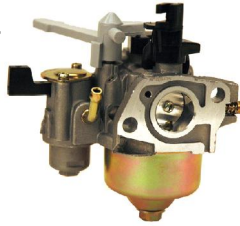

RETAIL - \$62.56

22-13193

Honda Replacement Carburetor
Part #16100-ZE1-825
Fits models GX140

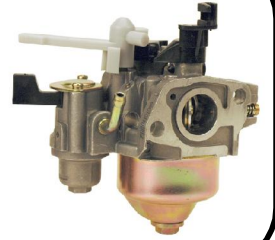

RETAIL - \$69.57

22-13194

Honda Replacement Carburetor
Part #16100-ZE2-W71
Fits models GX160



RETAIL - \$75.32

22-13196

Honda Replacement Carburetor
Part #16100-ZE2-W71
Fits models GX240

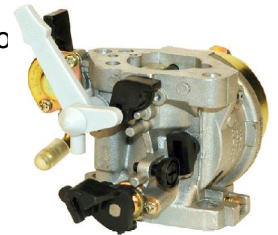

RETAIL - \$71.04

22-13142

Tecumseh Rplmt. Carburetor
Part #640330A
Fits models OHV140-175, OV490
includes fuel solenoid



RETAIL - \$78.57

22-13146

Tecumseh Rplmt. Carburetor
Part #632230
Fits models H50, H60



RETAIL - \$85.63

22-13149

Tecumseh Rplmt. Carburetor
Part #632795A
Fits models TVS90



RETAIL - \$78.00

22-13152

Tecumseh Rplmt. Carburetor
Part #640025C
Fits models OHH55 - OHH65



RETAIL - \$75.04

22-13566

Tecumseh Carburetor
Part #640350
Fits models LV195EA, LV195XA



RETAIL - \$78.00

22-14111

Briggs 498170 for most vertical
shaft w/ primer button 4-7HP



RETAIL - \$48.70

FAX (800) 4804

22-15241

Zama C1Q-S183 for Stihl BR500, BR550, BR600 Blowers, Stihl # 4282-120-0608

RETAIL - \$52.21



22-15242

Zama C1Q-S8G for Stihl BG45, BG55, BG65, BG85, SH55 85 blowers. Stihl # 4229-120-0603

RETAIL - \$30.24



22-15244

Zama C1Q-S118 for Stihl TS41, TS420 cut off saws. Stihl # 4238-120-0600

RETAIL - \$114.25



22-15246

Zama C1Q-S176 for Stihl FS87, FS90, FS110 string trimmers. Stihl #4180-120-0613

RETAIL - \$45.32



22-15245

Zama C1Q-S269 for MS171, MS181, MS201, MS211. Stihl # 1139-120-0619

RETAIL - \$48.17



22-15292

Zama C1Q-S186 for Stihl FS38, FS45, FS46, FS55, HL45, KM55, FC55 Stihl #4140-120-0619

RETAIL - \$39.08



22-15247

Zama C3A-S39B for Stihl MS340, MS360, 034 036 chainsaws Stihl #1125-120-0615

RETAIL - \$117.52



22-15611

MTD 951-12705, 951-10794. Fits 31 series models & also Cub Cadet

RETAIL - \$57.60



22-WYL-19-1

Walbro WYL-19-1 OEM for Shindaiwai models C230, T230

RETAIL - \$89.20

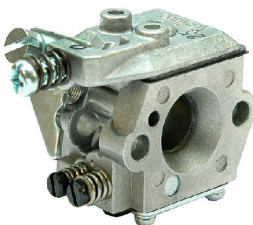

22-C1U-K52

Zama C1U-K52. OEM Fits Echo models SRM2100, GT2000, GT2100, ST2000SB, PAS and PDSR.

RETAIL - \$56.46

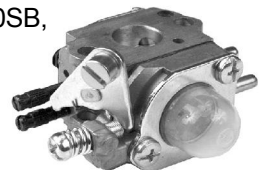

22-RB-K70A

OEM Zama Carburetor. Fits Echo models GT200, GT201, SRM200, SRM201, SRM130, SRM231, HC160, HC180 and HC200.

RETAIL - \$58.84



22-C1U-K54

Zama OEM C1U-K54A Fits Echo TC2100, Mantis Tillers,

RETAIL - \$66.32





STARTERS - ELECTRIC & RECOIL



ROTARY

PART #	DESCRIPTION	RETAIL
26-9796	Briggs Electric Starter Twin Cylinders #497595	\$ 88.55
26-9797	Briggs Electric Starter Twin Cylinders #467596	\$ 90.30
26-9798	Briggs Electric Starter HD Single Cyl, #497401	\$ 99.40
26-9799	Briggs Electric Starter V-Twin HD #498148	\$127.50
26-9974	Briggs Electric Starter, 16 tooth gear, #396306	\$129.65
26-10709	Briggs Electric Starter, steel flywheels, #691564	\$129.65
26-12494	Briggs Electric Starter #693551, 14 tooth gear	\$105.45
26-12954	Briggs Electric Starter #693552, CCW, 14tooth	\$154.15
26-12330	Briggs Recoil Starter #693900, fits 8HP	\$ 70.25
26-12329	Briggs Recoil Starter #497830, 495766	\$ 38.60
26-12087	Honda Electric Starter GX610-620, 31200ZJ1841	\$389.35
26-10674	Honda Electric Starter GX340, 31210ZE3013	\$278.37
26-9064	Honda Recoil Starter GX110-160 28400ZE1003ZA	\$ 87.98
26-10379	Honda Recoil GX340-390 metal pawls 28400ZE3W01	\$ 98.60
26-12079	Honda Recoil GX160, 2 metal pawls 28400XH8023YA	\$ 74.69
26-10241	Kawasaki Electric Starter, #21163-2077	\$440.93
26-10561	Kawasaki Electric Starter, 10T, #21163-7010	\$203.16
26-10806	Kawasaki Elec. Starter FB460,FC400 21163-2073	\$364.07
26-12279	Kawasaki Electric Starter 21163-7014, FH541,721	\$360.90
26-12430	Kawasaki Electric Starter 21163-2093, FC540V	\$514.09
31-12130	Starter Solenoid fits Kohler and Kawasaki	\$320.73
26-9800	Kohler Electric Starter M10-M16. 10T #41-098-06	\$218.75
26-9802	Kohler Electric Starter 6-8HP, 16T, #41-098-08	\$223.08
26-9997	Kohler Electric Starter, CV12.5-14. 10T, 25-098-04	\$196.75
26-10262	Kohler Electric CH & CV Series 25-098-09 Denso	\$232.15
26-12281	Kohler Electric CH & CV Series 25-098-09 Delco	\$232.15
26-12993	Kohler Electric Courage Single 20-098-01	\$120.00
26-12710	Kohler Electric Courage V-Twin 32-098-01	\$165.35
26-9979	Tecumseh Electric Starter TVM,OVM,XL #36680	\$155.79
26-9980	Tecumseh Electric Starter, 16 tooth, #36795	\$155.79
26-9981	Tecumseh Electric Starter, 10 tooth, #36914	\$173.00
26-9990	Tecumseh Electric Starter, 11 tooth,#33835, 37425	\$178.91
26-12654	Tecumseh Recoil #590742, HSSK50-70	\$ 37.98
26-10983	Tecumseh Recoil #590737, TVS Sears series	\$ 33.49



26-9796



26-9798

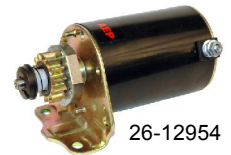

26-12954



26-12087



26-12079



31-12130



26-10262

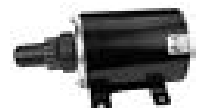

26-9979



26-12079

MANY MORE OPTIONS AVAILABLE
orders@boettchersupply.com



TOOLS

For every small engine shop



****PRICES SUBJECT TO CHANGE!!****

33-12223

Sea Foam Motor Treatment for Small Engine Applications. Works and Performs Instantly. Stabilizes fuel. Cleans carburetor. Cleans carbon. Removes moisture. Assures fast starts. Frees sticky rings. Restores power. Upper cylinder lube. Smooths rough idle. 16 oz can



RETAIL - \$12.50

G4 DOT Reacher

Industrial quality lightweight pick-up tool.

33-10640 - 40" RETAIL - \$26.35

33-10648 - 48" RETAIL - \$32.99



DURASKIN Disposable Nitrile Gloves

5 ml thickness, 9-1/2" length, black, 100 per box

Part #	Size
32-13040	Medium
32-13060	Large
32-13061	X-Large

RETAIL - \$20.50



ROTARY

BULK OIL FILTERS

QTY	DESCRIPTION	RETAIL
19-6929	Single Oil Filter Rpl. Briggs 492932	\$ 12.50
19-12861	12 PACK 19-6929	\$128.40
19-15647	24 PACK 19-6929	\$190.80
19-7916	Single Oil Filter Rpl. Kohler 12-050-01	\$ 9.97
19-12862	12 PACK 19-7916	\$119.64
19-15648	24 PACK 19-7916	\$190.80
19-5909	Single Oil Filter Rpl. Kohler 52-050-02	\$ 10.47
19-12863	12 PACK 19-5909	\$ 92.40
19-15649	24 PACK 19-5909	\$190.80
19-6600	Single Oil Filter Rpl. Kawasaki 49065-7010	\$ 12.50
19-12864	12 PACK 19-6600	\$120.60
19-15650	24 PACK 19-6600	\$190.80

PHONE (800) 569-2700

HONDA ENGINES

The correct model and spec number are needed to find the correct replacement engine. Arrows show where the numbers should be located.

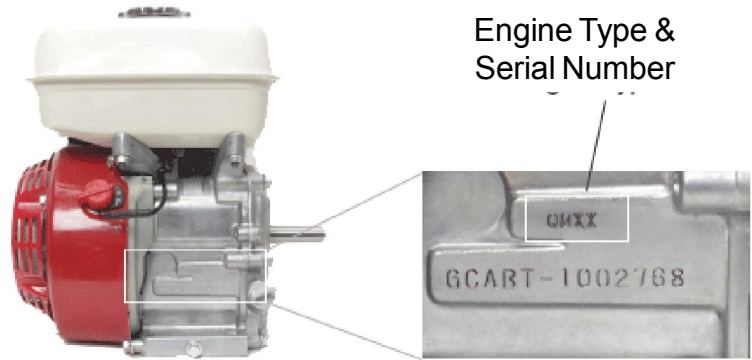

To find the **model number**, look for a model number sticker on the engine. All Honda engines model numbers start with the letter “G,” such as “G100”, “GX610”, or “GXV160.”

The **engine type code** is stamped into the side of the engine, usually close to the serial number. Engine type codes may be up to 4 characters. If a code is less than 4 characters, you may see asterisks as placeholders (i.e. an engine stamped with QX** is a QX type engine.)

The **engine serial number** is stamped into the side of the engine. All Honda engine serial numbers have a 4 or 5 letter prefix followed by a 7 digit number.

ENGINE LINES

<u>GX</u>	<u>160</u>	<u>UT2</u>	<u>QX2</u>
Engine series Vertical engine	Engine Size (cc displace.)	Man. Location Model Version	Engine type code Variant of engine**
** Variants include:	<u>Q</u> - straight shaft <u>C</u> - Cyclone Filter	<u>T</u> - Threaded shaft <u>E</u> - Electric Start	<u>H</u> - Gear Reduction

MODEL	DESCRIPTION	RETAIL
GX160UT2-QX2	5.5 HP Basic Recoil, 3/4" Crank	\$ 363.80
GX160UT2-QXE2	5.5 HP Basic, Electric, 3/4" Crank	\$ 581.40
GX160UT2-HX2	5.5 HP Recoil, 3/4" Crank w/ 6:1 Gear Reduction	\$ 552.60
GX160UT2-TX2	5.5 HP Recoil, 5/8" threaded crank	\$ 392.40
*GX240UT2-QA2	7.9 HP Basic, Recoil, 1" Crank	\$ 612.00
GX340UT2-QNE2	10.7 HP Basic, Electric, 1" Crank	\$ 950.40
GX390UT2-QAE2	11.7 HP Basic, Electric, 1" Crank	\$ 907.20
*GX390UT2-QXC9	11.7 HP Basic, Recoil, 1", Cyclone	\$ 799.00
GX630RH-QAF1	20.3 HP Basic, Electric, 1" crank, No tank, no muffler	\$1576.80

***SPECIAL PRICING - LIMITED TO AVAILABILITY**

FAX (800) 489-4804

Popular Parts



PART #	DESCRIPTION	RETAIL
15400PLMA02PE	Oil Filter fits 18-24hp V-twins	\$ 8.14
16010ZE1812	Carburetor Gasket Set, fits many GX110, GX120, GX160 engine	\$13.66
16100Z0L023	Carburetor, fits many GCV160A1A on HRR216	\$20.02
16100Z0L853	Carburetor, fits GCV160S1A1	\$17.85
16910ZE8015	Fuel Filter - fits most V-twins	\$10.60
17210ZE1517	Air Filter w/ precleaner Fits many GX110, 120, 140, 160	\$ 7.94
17210ZJ1842	Air Cleaner - flat panel style fits GX610K1,620K1,GXV610K1,620K1	\$37.04
34150ZH7023	Oil Alert Sensor fits many GX120,GX160,GX200 GX240,GX270,GX340,GX390	\$36.14

ENGINES LINES



16100Z0L023



15400PLMA01PE



17210ZE1517



16910ZE8015



34150ZH7023



17210ZJ1842

PHONE (800) 569-2700



Popular Parts

ENGINE LINES

491056
Tall Oil Filter
3.40" height - 2.92" od

RETAIL - \$7.85



492932
Short Oil Filter
2.3" height - 2.92" OD

RETAIL - \$9.65



594593
Carburetor
Fits most 31A,31B,31C
model engines

RETAIL - \$108.40



808656
Fuel Pump
Three outlet, two bolts
LIMITED AVAILABILITY

RETAIL - \$20.70



799868
Carburetor
Fits most 124000
model engines

RETAIL - \$49.65



845907
Regulator
2 yellow wires, 1 red

RETAIL - \$74.70



692317
90 degree plastic elbow for
carburetors, with metal
push-in style end
RETAIL - \$4.75



799863
Fuel tank - fits many
121, 122 series engines

RETAIL - \$68.00



592831
Alternator
1 Red wire, 1 Black wire
White Rec, two pins
RETAIL - \$74.30



592830
Alternator
Two Black wires,
yellow rec, two pins
RETAIL - \$74.30



IDENTIFYING YOUR BRIGGS & STRATTON ENGINE



The Model, Type and Code numbers, stamped directly into the engine, are used to identify our engines. Engines used in lawnmower applications usually have these numbers stamped into the blower housing, muffler heat shield or a few inches above the spark plug. Depending on the type of engine shroud used, the engine numbers may be covered. It may be necessary to remove this shroud in order to locate the Model, Type, and Code.

Many horizontal shaft, overhead valve engines have these numbers stamped into the OHV rocker cover. However, on certain overhead valve powered generators, the equipment manufacturer installs a decorative chrome rocker cover OVER our cover. If your engine has a decorative cover, it may be necessary to remove it in order to locate the Model, Type, and Code.

The pictures below show the different style of Briggs & Stratton Engines and where the model, type and code identification numbers should be located.

Also, be aware that the numbers found on the Engine Emissions Label can be confused with the engine Model, Type, and Code. Unfortunately, these numbers cannot be used to identify your engine.

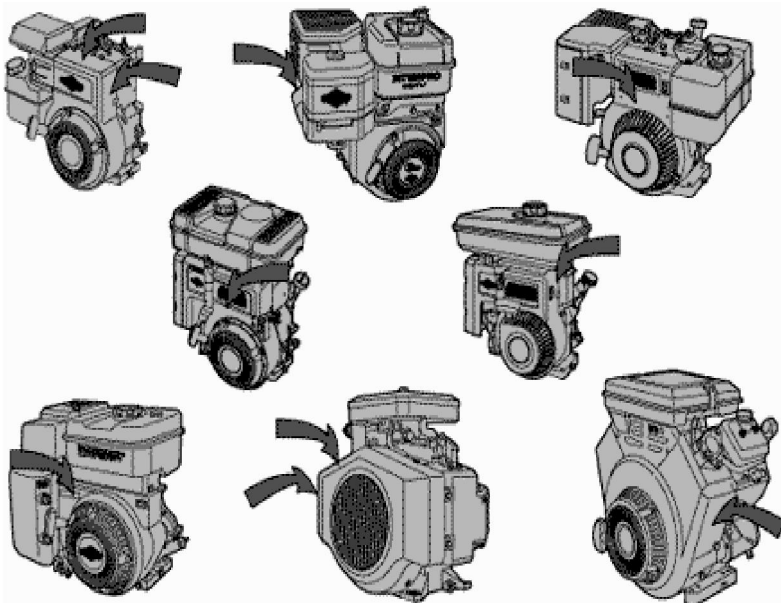

THE CORRECT MODEL, SPEC AND CODE DATE ARE NEEDED TO LOOK UP THE CORRECT PARTS. THE FACTORY HAVE STARTED PLACING THESE NUMBERS ON THE BLOCK OF THE ENGINE INSTEAD OF THE SHROUDING. THE FAMILY NUMBER ON THE SHROUDING ***CANNOT*** BE USED TO LOOK UP PARTS

ENGINES LINES

ALWAYS GET THE CODE DATE

The code number identifies the assembly date of the engine. In *most* instances it is necessary to know the code number as well as the model and type number when performing adjustments, repairs or ordering replacement parts for an engine. Here is how it works:

CODE 01061201, The code is the manufacturing date and is read as follows:

01 - Year; **06** - Month;
12 - Day; **01** - Assembly Line and Plant

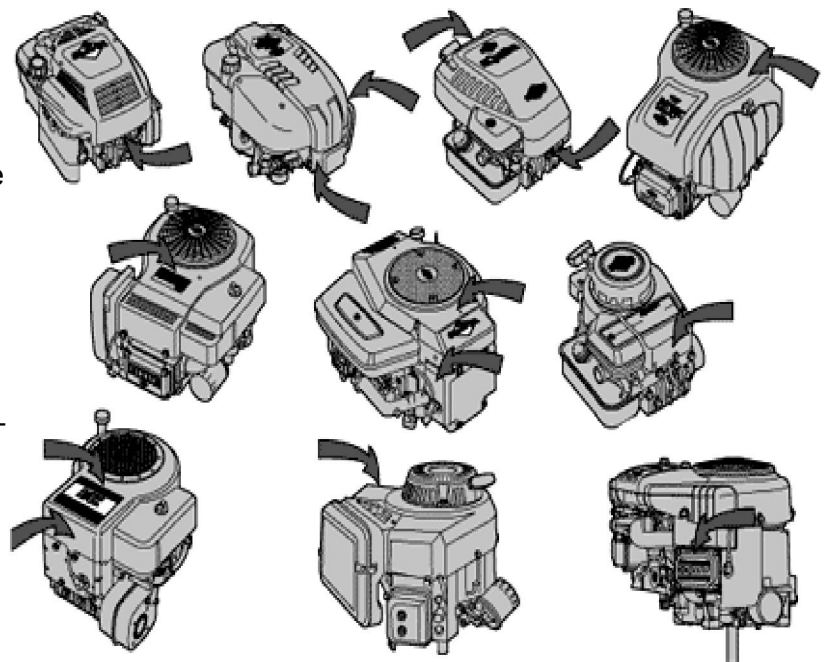

PHONE (800) 569-2700



BRIGGS & STRATTON VERTICAL ENGINES

ENGINE LINES

PART #	HP	DESCRIPTION	CRANK	RETAIL
*126M02-1625	625	Quantum Series, Recoil	25mmX3-5/32"	\$ 185.00
104M02-0021	725	Exi Ready Start, Recoil	7/8"x3-5/32"	\$ 183.00
104M02-0196	725	Exi Ready Start tapped 3/8-24,	25mmX3-5/32"	\$ 195.00
*121Q07-2060	850	Recoil Start Engine	7/8"x3-5/32"	\$ 437.00
125P02-0012	850	Pro Series, Recoil,	25mmX3-5/32"	\$ 238.00
21R807-0072	10.5	Intek, ES, Recoil, No Tank,	1" x 3-5/32"	\$ 509.00
*217902-3015	11.5	Intek OHV Recoil, no tank/muffler	1" x 3-5/32"	\$ 678.80
31R907-0006	17.5	I/C Electric / Recoil , 9amp,no tank	1" x 3-5/32"	\$ 588.45
31R907-0007	17.5	I/C Electric only , 9amp, no tank	1" x 3-5/32"	\$ 573.85
31R976-0016	17.5	Intek Electric/Recoil, no tank	1" x 3-5/32"	\$ 530.65
*31P777-3202	18	Intek Electric, Remote Throttle	1" x 3-5/32"	\$ 926.40
33S877-0019	19	Intek Elec/Recoil, no tank, muffler incl.	1" x 3-5/32"	\$ 626.10
*33M977-0001	21	Intek OHV Electric start, no tank	1" x 3-5/32"	\$1128.00
44S977-0032	24	ELS V-Twin, Elec., 16amp, no tank	1" x 3-5/32"	\$ 919.55
49T877-0004	27	5-Stage Air Filter,no muffler/tank	1-1/8"x 4-5/16"	\$1145.70
		ELS V-Twin, Electric Start		

**Engines on Closeout, Limited Availability*

**CALL US WITH YOUR MODEL
AND SPEC FOR A QUOTE ON A
NEW BRIGGS ENGINE**



FAX (800) 489-4804

BRIGGS & STRATTON HORIZONTAL ENGINES



PART #	HP	DESCRIPTION	CRANK	RETAIL
83132-1035	550	Basic Series Recoil	3/4" x 2-27/64"	\$ 230.00
83152-1049	550	6:1 Gear Reduction, Recoil	3/4" x 2-27/64"	\$ 513.60
130G32-0022	900	Basic Series Powerbuilt, Recoil	3/4" x 2-27/64"	\$ 270.00
130G52-0182	900	6:1 Gear Reduction CCW, OHV	3/4" x 2-27/64"	\$ 390.00
13R232-0001	950	OHV Engine, Basic	3/4" X 2-7/16"	\$ 230.00
15T212-0160	1150	Intek Powerbuilt, Aluminum, Recoil	1" x 2-7/8"	\$ 310.00
19N132-0051	1450	Intek OHV, Cast Iron Bore, Recoil	3/4" x 2-1/2"	\$ 480.00
19N132-0035	1450	Intek OHV, Cast Iron, Recoil, 7/16-20	1" x 3-31/64"	\$ 470.00
19N132-0055	1450	Intek OHV, Cast Iron Bore, 3/8-24	1" x 2-49/64"	\$ 480.00
25T237-0045	2100	Intek, Electric & Recoil, 10amp	1" x 21/32"	\$ 610.00
VANGUARD MODELS - 3 year warranty				
19L232-0036	10	OHV, Oil Sensor, Transport Guard	1" x 2-29/32"	\$ 580.00
*305447-0568	16	OHV, Electric, Recoil, 16Amp	1" x 2-29/32"	\$1614.00
356447-3079	18	OHV Electric start only, no tank	1" x 2-29/32"	\$1505.00
*385447-3020	21	OHV, Electric, no tank, no muffler	1" x 2-29/32"	\$2087.00

ENGINES LINES

**Engines on Closeout, Limited Availability*



PHONE (800) 569-2700



Kawasaki Tune Up Kits

Everything needed for a full engine service

Quick, clean, organized! - One part to bill out, reduces inventory!

****LIMITED AVAILABILITY**

Application: **FR651V, 691V, 730V & All FS Series**

PART #	RETAIL
**99969-6372 (10W40-99969-6296)	\$51.45
99969-6543 (10W40-99969-6296)	\$60.34
99969-6544 (10W40-99969-6296)	\$61.17

Kit contains: 2 bottles oil, 1 oil filter (49065-0721), 1 fuel filter (49019-0027), 1 prefilter (11013-7046), 1 air filter (11013-0752), 2 spark plugs (BPR4ES)



Application: **FX751V, 801V, 850V**

PART #	RETAIL
99969-6419 (10W40-99969-6296)	\$86.95
99969-6420 (20W50-99969-6298)	\$87.75

Kit contains: 2 bottles oil, 1 oil filter (49065-7010), 1 fuel filter (49019-0027), 1 inner filter (11013-7045), 1 outer filter (11013-7044), 2 spark plugs (BPR4ES)



Application: **FX651V, 691V, 730V**

PART #	RETAIL
**99969-6374 (10W40-99969-6296)	\$74.49
99969-6527 (10W40-99969-6296)	\$87.04
99969-6528 (20W50-99969-6298)	\$87.84

Kit contains: 2 bottles oil, 1 oil filter (49065-0721), 1 fuel filter (49019-0027), 1 inner filter (11013-7045), 1 outer filter (11013-7044), 2 spark plugs (BPR4ES)



Application: **FH601V, 641V, 661V, 680V, 721V, & 770D KAI**

PART #	RETAIL
99969-6413 (10W40-99969-6296)	\$92.18
99969-6414 (20W50-99969-6298)	\$92.92

Kit contains: 2 bottles oil, 1 oil filter (49065-0721), 1 fuel filter (49019-0027), 1 inner filter (11013-7019), 1 outer filter (11013-7020), 2 spark plugs (BPR4ES)



Application: **FH451V, 500V, 531V, 541V, 580V (ALL with standard filter)**

PART #	RETAIL
99969-6417 (10W40-99969-6296)	\$58.03
99969-6418 (20W50-99969-6298)	\$58.78

Kit contains: 2 bottles oil, 1 oil filter (49065-7010), 1 fuel filter (49019-0027), 1 prefilter (11013-7033), 1 air filter (11013-7002), 2 spark plugs (92070-7003)



Application: **FH481V, 541V, 600V**

PART #	RETAIL
99969-6539 (10W40-99969-6296)	\$71.83
99969-6540 (20W50-99969-6298)	\$73.54

Kit contains: 2 bottles oil, 1 oil filter (49065-0721), 1 fuel filter (49019-0027), 1 air filter (11013-7048), 2 spark plugs (BPR4ES)



Application: **FH381V, 430V, 480V, 541V, 580V, ALL KAI**

PART #	RETAIL
99969-6415 (10W40-99969-6296)	\$67.69
99969-6416 (20W50-99969-6298)	\$68.46

Kit contains: 2 bottles oil, 1 oil filter (49065-7010), 1 fuel filter (49019-0027), 1 prefilter (11013-7025), 1 air filter (11013-7031), 2 spark plugs (92070-7003)



KAWASAKI

Kawasaki

— ENGINES —

Extend the life of your Kawasaki engine with specially-formulated, premium K-Tech engine oil, specifically designed for use in Kawasaki Engines and ideal for all engines where API, CJ-4, SL and JASO MA oil is recommended. Tested and approved by Kawasaki engineering and refined in the U.S.A.



99969-6081
Qt bottle 10W30 -
RED cap
Retail - \$7.08



99969-6281
Qt bottle SAE30 -
YELLOW cap
Retail - \$6.93



99969-6296
Qt bottle 10W40 -
GREEN cap
Retail - \$7.38



99969-6298
Qt bottle 20W50 -
BLUE cap
Retail - \$7.67

Two-Cycle Oil



PART #	DESCRIPTION	RETAIL
99969-6082C	1-Gallon Mix 2.6oz	\$1.67
99969-6083C	2-Gallon Mix 5.2oz	\$2.50
99969-6084C	2.5-Gallon Mix 6.4oz	\$2.66

Packaged in 6 packs - 48 per case

KAWASAKI

PHONE (800) 569-2700

Oil Filters		Fuel Filters
<p>49065-7010 Fits most engines</p>  <p>RETAIL - \$10.28</p>	<p>49065-0721 Fits most FR / FS / FX</p>  <p>RETAIL - \$10.33</p>	<p>49019-0027 Fits most engines</p>  <p>RETAIL - \$ 5.33</p>
Air Filters		
<p>11013-0752 Fits FR651V-FR730V & FS481V-FS730V engines</p>  <p>RETAIL - \$15.41</p>	<p>11013-7046 Precleaner for 11013-0752</p>  <p>RETAIL - \$ 4.58</p>	<p>11029-0031 11013-0752 & 11013-7046 together</p>  <p>RETAIL - \$17.52</p>
<p>11013-7027 Fits FH601V - FH721V</p>  <p>RETAIL - \$18.77</p>	<p>11013-7019 Fits FH601V - FH721V, FH770DN FD750D, FD791D (Inner filter)</p>  <p>RETAIL - \$26.32</p>	<p>11013-7020 Fits FH601V - FH721V, FH770DN FD750D, FD791D (Outer Filter)</p>  <p>RETAIL - \$23.35</p>

FLEXIBLE OIL DRAIN HOSE

- Hi-temperature, heavy duty braided rubber hose designed for durability
- Pressure tolerance 400 psi.
- Durable all brass fittings for quality and service
- Tethered rubber loop maintains connection between hose and threaded cap
- Fittings convert to SAE wrench size



51044-0902

Flexible Oil Drain Hose
16" Length x 3/4" width

RETAIL - \$51.09



MUFFLERS

- Durable stainless steel construction
- No paint flake
- Rust resistant
- Bolt on ready

#	Part #	Description	RETAIL
481V, 541V, 600V (603cc engines)			
1	49070-0880	Horizontal, High Mount	\$214.93
2	49070-0881	Horizontal, Low Mount	\$190.06
651V, 691V, 730V, (726cc engines)			
3	49070-0877	Horizontal, High Mount	\$214.51
4	49070-0878	Horizontal, Low Mount	\$190.14
751V, 801V, 850V (852cc engines)			
5	49070-0879	Horizontal, Low Mount	\$212.56
Parts commonly purchased with these mufflers			
	11060-7016	Muffler Gasket (2)	\$ 1.63
	92210-7027	Nut (4)	\$ 1.51



HORIZONTAL ENGINES		
RETAIL	DESCRIPTION	RETAIL
*CH395-3011	9.5HP 1" Variable speed/Manual Throttle	\$ 527.00
*CH620-3050	18HP Grasshopper (same as CH620-3129)	\$1652.14
CH620-3129	18HP Grasshopper Morigde ZTR	\$1651.73
*CH730-0011	25HP Air Comp., 1-7/16"x4-5/16"	\$2074.56

VERTICAL ENGINES		
RETAIL	DESCRIPTION	RETAIL
*SV470-3200	15HP Walker Replacement Engine	\$ 914.24
*SV600-3217	20HP MTD Replacement 1"	\$ 938.04
*SV601-3212	20HP MTD Replacment 1"	\$ 962.01



**Engines on Closeout, Limited Availability*

Many More Kohler Engines Available - Call for Pricing!!

KOHLER

Standard Features -

- Twin Cylinder
- 1" x 3.16" PTO Length
- Cast-Iron Liners
- Pressure Lubrication
- PRO Perform Air, Fuel & Oil Filters
- Automotive Style Dipstick
- Nitrite Exhaust Valves
- Quiet Cam
- Fixed Grass Screen Guard
- Pulse Fuel Pump
- Mechanical Governor
- EVAP/CARB
- No muffler included



The New **CONFIDANT** was designed with WAWB mowers in mind. They provide more power at a better price, complete with a Heavy-Duty Air Cleaner.

PART #	DESCRIPTION	RETAIL
ZT720-3016	21HP Recoil Start	\$1400.00
ZT720-3017	21HP Electric Start	\$1500.00
32-786-03	Vertical Muffler	\$ 147.84
32-786-04	Horizontal Muffler	\$ 160.82

Kohler Courage Horizontal OHV

- Dual Ball Bearings -- Cast Iron Cylinder Liner
- Dual Element Air Cleaner -- Dual Oil Fill and Drain
- Automatic Low Oil Engine Shutdown
- Engine Mounted Throttle & Choke Control
- Large 3.6 L Metal Fuel Tank w/ Debris Screen
- Large Capacity Muffler with Heat Shield
- 2 Year Consumer Warranty,
- 90 Day Commercial Warranty



KOHLER[®] ENGINES



**Great for Tillers, Edgers,
Concrete Saws, Log Splitters,
Go-Karts, Pumps, etc.**

PART #	HP	DESCRIPTION	RETAIL
SH265-3011	6.5 HP	3/4" Basic Model	\$265.00
SH265-3031	6.5 HP	3/4" Basic Model W/ Electric Start	\$382.81
18-068-08		Low Profile Muffler	\$ 82.72
18-068-14		Muffler & Deflector	\$ 44.53

KOHLER



TECUMSEH PARTS ARE SUBJECT TO LIMITED AVAILABILITY.
Engines are no longer available, but we will continue to stock and order parts



PHONE (800) 569-2700

KOHLER OIL, OIL & FUEL FILTERS

PART #	DESCRIPTION	RETAIL
25-357-03	30wt - Quarts	\$ 5.77
25-357-06	10W30 - Quarts	\$ 5.88
25-357-42	20W50 - Quarts	\$ 6.26
12-050-01	Oil Filter, CV & CH 17-25	\$11.97
52-050-02	Oil Filter, M18-20, CV 7 CH 11-15	\$12.97
24-050-13	In-Line Fuel Filter, 15 mic, 1/4" Line	\$ 9.47
25-050-07	In-Line Fuel Filter, 75 mic, 1/4" Line	\$ 6.97
25-050-22	In-Line Fuel Filter, 51 mic, 1/4" Line	\$ 6.97



KOHLER ENGINES



TUNE UP KITS - incl. Oil, Air Filter, Fuel Filter, Spark plugs

PART #	FOR MODELS	AIR FILTER	RETAIL
20-789-01	SV840-620	20-083-06	\$42.95
12-789-01	CV11-15	12-083-05	\$42.95
12-789-02	CV11-15, 460-493 PRO	12-083-10	\$42.95
24-789-01	CV17-23, 724-740 CH18-25, 730-740	47-083-03	\$44.50
24-789-02	CV18-30, 625-740 CH18-25, 730-750 PRO	24-083-03	\$44.50
24-789-03	CV17-27, 73-740 WAWB	45-083-02	\$44.50
20-789-01	SV840-620	20-083-06	\$42.95
25-789-01	CV18-25, 625-752 CH18-25, 730-52 HDAC	25-083-01	\$49.95
32-789-01	SV710-740	32-083-03	\$44.50
32-789-02	KT715-745	32-083-09	\$44.50

KOHLER

FAX (800) 489-4804



KOHLER BEST SELLERS

PART #	DESCRIPTION	RETAIL	PART	DESC.	RETAIL
12-883-05	Air Filter w/ Prefilter CV11-15	\$17.97	12-083-05	Air Filter	\$14.97
12-883-10	Air Filter w/ Prefilter CV11-15 Large Capacity	\$17.97	12-083-08	Prefilter	\$ 4.55
14-083-01	Air Filter Courage XT Series	\$ 9.97	12-083-10	Air Filter	\$14.97
14-083-02	Prefilter Courage XT Series	\$ 4.55	12-083-12	Prefilter	\$ 4.55
14-083-15	Air Filter Courage XT675-775	\$ 9.97			
16-083-04	Air Filter KT700,ZT700 Series	\$19.97			
16-083-05	Precleaner KT700,ZT700 Ser	\$ 4.55			
20-883-06	Air Filter w/ Prefilter Courage Single SV470-610	\$17.97	20-083-06	Air Filter	\$14.97
24-883-03	Air Filter w/ Prefilter CH25 and CV25	\$19.97	20-083-04	Prefilter	\$ 4.55
25-083-01	HD Primary Air Filter	\$22.97	24-083-03	Air Filter	\$16.97
25-083-04	HD Safety Inner Filter	\$22.97	24-083-05	Prefilter	\$ 4.55
25-883-03	Air Filter w/ Prefilter K241-321, M8	\$19.97			
32-883-03	Air Filter w/ Prefilter Courage Twin SV710-740	\$19.97	32-083-03	Air Filter	\$16.97
32-883-06	Air Filter w/ Prefilter Courage PRO Twin SV810-840	\$19.97	32-083-05	Prefilter	\$ 4.55
32-883-09	Air Filter/Pre 7000 series KT715-KT745	\$19.97	32-083-06	Air Filter	\$16.97
45-883-02	Air Filter w/ Prefilter K341, M10-16, CV17-25	\$19.97	32-083-08	Prefilter	\$ 4.97
47-883-01	Air Filter w/ Prefilter KT Series Sq. Style,CH11-15	\$19.97	32-083-09	Air Filter	\$16.97
47-883-03	Air Filter w/ Prefilter QS Models, CH & CV 17-25	\$19.97	32-083-10	Prefilter	\$ 4.55
			45-083-02	Air Filter	\$16.97
			45-083-01	Prefilter	\$ 4.55

**Numbers with "883" are Air Filter and Precleaner Kits
Numbers with "083" are either Air Filter OR Precleaner**

PHONE (800) 569-2700

CARBURETOR, FLOAT & SOLENOID KITS

**Command CH11-15,
CV11-16**



Carburetor Repair Kit **12-757-01**
(Walbro Carburetor)
Retail - \$13.28

**Command CH11-16, CH410-450,
CV11-16, CV430-450,
Courage SV470-620**



Carburetor Repair Kit **12-757-03**
(Walbro Carburetor)
Retail - \$23.61

**Command CH18-25,
CH620-740, Aegis LH630-755**

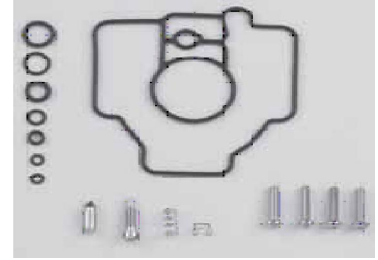

Carburetor Repair Kit **24-757-03**
(Keihin Carburetor)
Retail - \$75.55

**Command CV17-22,25, CV620-
670, CV724-740,
Aegis LV625-680**

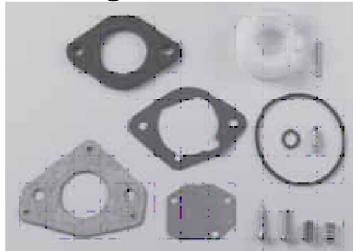

Carburetor Repair Kit **24-757-18**
(Nikki Carburetor)
Retail - \$52.48

KOHLER
ENGINES

**Command CV22-23, CV675-680,
Courage SV710-740, SV810-840**



Carburetor Repair Kit **24-757-46**
(Keihin Carburetor)
Retail - \$92.59

**K-Series K91-321,
Magnum 8-14**

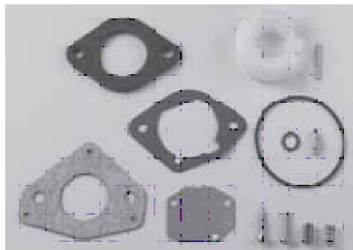

Carburetor Repair Kit **25-757-01**
(Kohler Carburetor)
Retail - \$14.24

**K-Series K321-582,KT17-19,
Magnum M14-20**



Carburetor Repair Kit **25-757-02**
(Kohler Carburetor)
Retail - \$14.95

**K-Series K91-341,KT17-19,
Magnum M8-20,MV16-20**



Carburetor Repair Kit **25-757-11**
(Walbro Carburetor)
Retail - \$59.75

**Command CH5, CH11-16, CV11-
16, CH410-450, CV430-450,
Courage SV470-620**

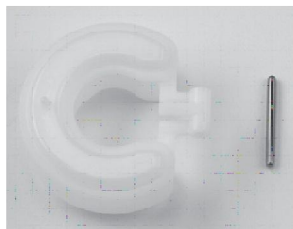

Float Repair Kit
12-757-02
Retail - \$8.84

**K-Series K91-582, KT17-19
Magnum 8-20**

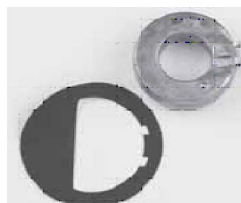

****LIMITED AVAILABILITY****

Float Repair Kit
25-757-03
Retail - \$17.74



**K-Series K91-K321,KT17-19,
Magnum M8-20, MV16-20**



Float Repair Kit
25-757-09
Retail - \$23.50

KOHLER

CARBURETOR, FLOAT & SOLENOID KITS

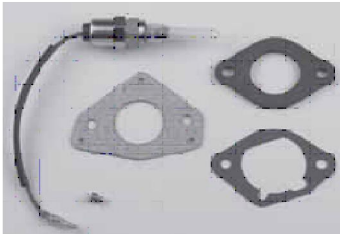
<p><i>Other kits available, call with your model and spec number for pricing!</i></p>	<p>Command CH11-16, CH410-450, CV11-16, CV430-450, Courage SV470-620</p>  <p>Solenoid Repair Kit 12-757-33 Retail - \$90.91</p>
<p>Command CV22-23, CV675-680, Courage SV710-740, SV810-840</p>  <p>Solenoid Repair Kit 24-757-45 Retail - \$166.33</p>	<p>Command CV17-22, CV25, CV620-670, CV724-740</p>  <p>Solenoid Repair Kit 24-757-22 Retail - \$146.90</p>

KOHLER ENGINES

TOP SELLING STARTERS

KOHLER



<p>Part # 20-098-11</p> <p>Bendix Drive fits SV470-SV620</p> <p>Retail - \$ 129.95</p>	<p>Part # 25-098-21</p> <p>Solenoid Shift, 10 tooth</p> <p>Fits CH13-CH26, CH410-CH1000, CV16-CV26, CV460-CV1000, LH630-LH775, LV625-LV680</p> <p>Retail - \$232.15</p>	<p>Part # 32-098-08</p> <p>Fits Courage Twin Cylinder</p> <p>Retail - \$165.35</p>
---	--	---

PHONE (800) 569-2700

FILTERS - AIR, FUEL -- ALL MODELS

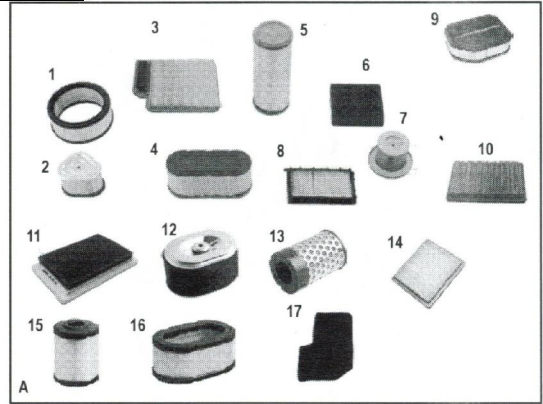
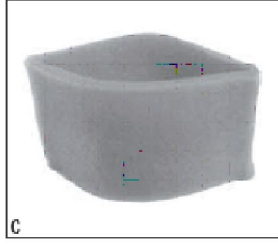
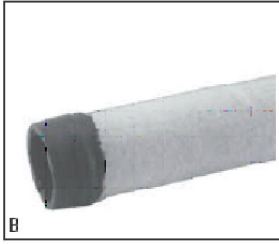

ELEMENTS/PRECLEANERS

Note: Elements and precleaners may appear differently for various models.

Style	Element (Photo A)	U.L. Element Equivalent	Inner Element (Photo B)	Precleaner (Photo C)	Model
1	45 083 02-S	52 083 04-S	—	45 083 01-S	CV17-26/730-745 (Commercial mowing)
1	47 083 01-S	47 083 04-S	—	52 083 01-S	CH11-15
4	63 083 03-S	—	—	63 083 04-S	CS4-6 (Standard, dual element)
4	63 083 11-S	—	—	63 083 12-S	CS8.5/250cc (Standard, dual element)
4	63 083 01-S	—	—	63 083 02-S	CS8.5/300cc, 10-12 (Standard, dual element)
6	63 083 06-S	—	—	—	CS4-6 (Foam, single element)
6	63 083 05-S	—	—	—	CS8.5/300cc, 10-12 (Foam, single element)
7	63 083 07-S	—	—	63 083 08-S	CS4-6 (Heavy-duty cyclonic)
7	63 083 10-S	—	—	63 083 09-S	CS8.5/250-300cc, 10-12 (Heavy-duty cyclonic)
8	63 083 13-S	—	—	63 083 14-S	CS8.5/250cc (Low profile, dual element)
4	63 083 15-S	—	—	63 083 16-S	CS10(931600),CS12 (941600)
3	20 083 06-S	20 083 07-S	—	20 083 04-S	SV470-620
2	12 083 05-S*	12 083 09-S*	—	12 083 08-S	CV11-16/460-493 (Standard, 2.8" High)
2	12 083 10-S*	12 083 13-S*	—	12 083 12-S	CV11-16/460-493 (Tall, 3.4" High)
1	47 083 03-S	24 083 08-S	—	24 083 02-S	CH/CV17-23 (Flat)
1	24 083 03-S	24 083 09-S	—	24 083 05-S	CH/CV25-26/730-745, ECH/ECV630-749 (Flat)
5	24 083 07-S	—	—	—	CH/CV17-22 Metal H.D. A/C
5	25 083 01-S	—	25 083 04-S	—	CH/CV17-26/730-745/LH640-775 Plastic H.D. A/C
5	25 083 02-S	—	25 083 03-S	—	ECH/ECV630-749
9	32 083 03-S	—	—	32 083 05-S	CV493
9	32 083 06-S	—	—	32 083 08-S	SV710-740 (Standard, 1.73" High)
4	66 083 01-S	—	—	66 083 03-S	SV810-840 (Large, 3" High)
10	14 083 01-S	---	---	14 083 02-S	LV625-680
11	14 083 09-S	---	---	---	XT-7
13	17 083 07-S	---	---	17 083 12-S	XT-7
13	17 083 21-S	---	---	17 083 15-S	CH270
12	18 083 04-S	---	---	18 083 05-S	CH395-440
9	62 083 04-S	---	---	62 083 03-S	SH265
14	14 083 15-S	---	---	---	CH940-1000 (with Low-Profile Air Cleaner)
15	16 083 01-S	---	---	16 083 02-S	XT650, XT675 (Paper)
16	16 083 04-S	---	---	16 083 05-S	ZT710-ZT740
--	18 083 13-S	---	---	---	ZT710-ZT740, KT715-KT745,
17	18 083 14-S	---	---	---	RH255, RH26 (Paper)
16	32 083 09-S	32 083 12-S	---	32 083 10-S	RH255, RH265, (Foam)
					KT715-KT745

Notes: *Includes element and rubber seal.

FILTER MINDER

Vacuum-type gauge detects air inlet restrictions, signaling when to service air filter (when yellow indicator reaches red line).

Kit No.	Mounting	Air Drawn From Model Item		
25 755 18-S	Remote	Air cleaner base plate or heavy-duty air cleaner elbow	CH/CV11-16/460-493,CH/CV17-26/730-745	1
25 755 24-S	Direct*	Heavy-duty air cleaner elbow	CH18-26/730-750, CV493	2
62 330 02-S	Direct	Heavy-duty air cleaner	CH/CV940-980	—
16 755 04-s	-----	-----	ZT710-ZT740	--

* Includes brass fittings, instructions.

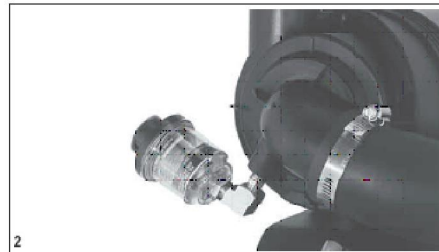

FAX (800) 489-4804

LUBRICATION -- ALL MODELS

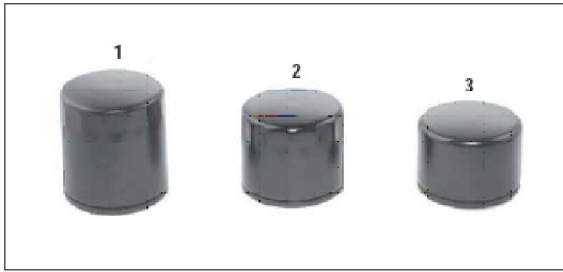

OIL FILTERS

Item	Part No.	Height	Models
1	52 050 02-S	3.47"	Premium Filter fits PRO Series
2	12 050 01-S	2.72"	Standard Filter
3	28 050 01-S*	2.32"	

*Shorter for applications with interference issues. Approx 15% less filter capacity

FUEL FILTERS -- ALL MODELS

Part No.	Inlet Hose I.D.	Micron	Shell Length	Model
25 050 21-S	1/4"	75	2.13"	Standard:CH/CV11-15/493
24 050 13-S	9/32"	9-12	2.35"	Standard:CH/CV17-25/730-740,750, 940-1000, LV625-680, LH640-755, SV470-620, SV710-840
24 050 03-S	5/16"	8-10	5.51"	Standard:All EFI (metal, hi pressure)
24 050 12-S	3/8"	80	5.51"	Standard: All EFI (plastic, lo pressure)
25 050 07-S	3/16, 1/4"	75	1.0"	Standard:CH/CV11-16/460-492 non-PRO (electric start)
25 050 22-S	1/4"	51	2.13"	Standard:CH/CV11-15/493 (fuel pump fed fuel)
25 050 42-S	5/16"	10	1.56"	Standard: ECH630-749/ECV630-749
14 050 14-S	1/4"	110	2.40"	Standard: XT, WH208 (in-nipple filter)
17 050 17-S	1/4"	60	1.60"	Standard: CH270-440

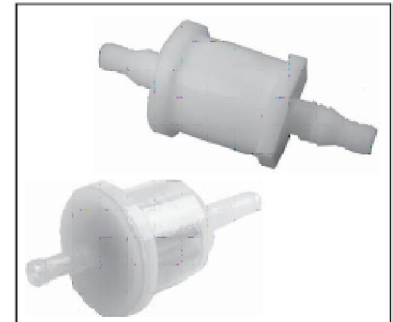

FUEL - ALL MODELS

MECHANICAL FUEL PUMPS

Part # (non-metallic)	Models	Item
12 559 02-S	CH/CV11-16/460-493	1
24 559 10-S*	CH18-25/730/740	2
62 559 01-S**	CH940-1000	3

* Integral Valve Cover. For #2 cylinder side (oil filter side) only. For engines below Serial No. 2520800017, also order Valve Train Kit 24 755 66-S to convert to compatible rocker arms.

**Integral Valve Cover. For #2 cylinder side (oil filterside) only

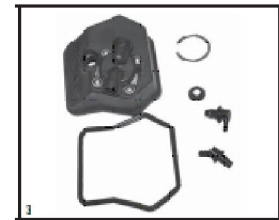
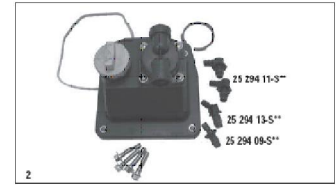

PULSE FUEL PUMP

Part No.	Model	Item
24 393 16-S	CH/CV17-25/730-740, LV625-675, ECH/ECV630-749, SV740-840, KT715-745, ZT710-740, ECV850-880	1



ELECTRIC FUEL PUMP

Part No.	Model	P.S.I. at 0 Delivery	Self-Prime Lift	Total Column
25 559 01-S	All except CH6, CS, & EFI	0.5-2.0	12"	6'

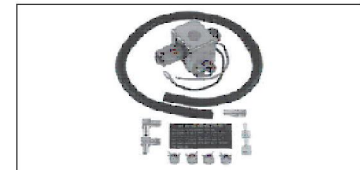

EFI ELECTRIC FUEL PUMP - High Pressure

Part No.	Model	P.S.I.	G.P.H.	AMPS Max
24 393 52-S	All EFI Engines	50	15.0	5.0



KOHLER

LUBRICATION

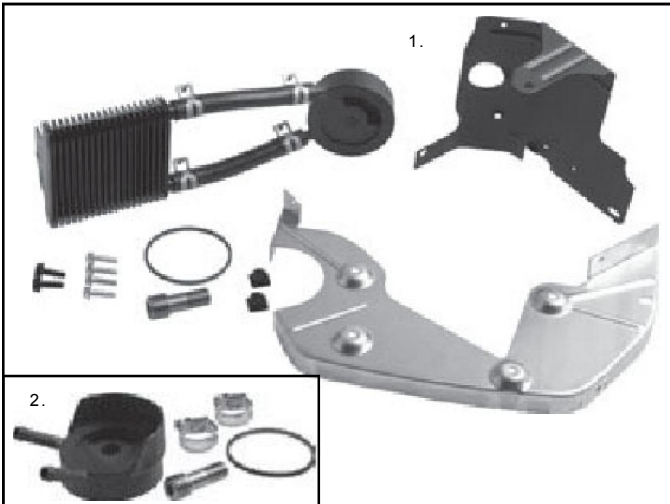

OIL COOLER KIT

To add cooler to engine. Reduces oil sump temperature up to 40 degrees

Item #	Kit No.	Material	Models
1	24 755 120-S*	Stanyl	CH/CV17-26/730-750
2	24-029-75-S	Stanyl	CH/CV17-26/730-750 (base only)

*Increases engine width on oil filter side by 1.25" (CH twins) or 0.625" (CV twins. Possible interference fit with side mount muffler.

OIL COOLER HOSE

Part No.	Length	I.D
24-326-17-S*	152mm (6")	9.52mm (3/8")
24-326-151-S	610mm (24")	

*Includes two hose clamps

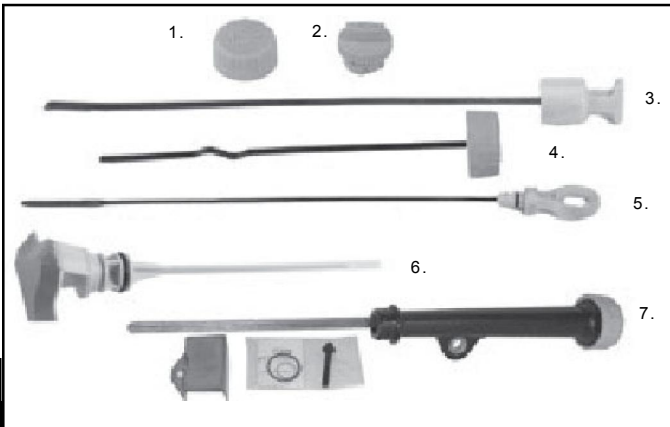

YELLOW ACCESSORIES

Item #	Part No.	Description	Models
1	24-755-46-S*	Oil Fill Cap Kit	CH18-26/730-750, LH640-775, ECH630-749
2	24-227-02-S**	Oil Fill Cap Assy	CH18-26/730-750, LH640-775,
3	12-038-10-S	Dipstick, bent tube	CH11-15
3	12-038-14-S	Dipstick, straight tube	CH11-15
4	12-038-02-S	Dipstick, straight tube	CV11-16/460-493
4	24-038-04-S	Dipstick, straight tube	CV17-26/730-750, ECV630-749
5	24-038-10-S***	Dipstick, bent/str tube	CH18-26/730-750, LH640-775
6	20-040-08-S	Dipstick, bent/str tube Standard	SV470-620
7	24-123-22-S****	Dipstick, tube kit	CH18-26/730-750, LH640-775

*For valve cover with pulse-type fuel pump, not mechanical fuel pump. Includes O-Ring

**For valve cover with mechanical fuel pump. Includes O-Ring

***Used with flare tube for improved seal. Standard since serial no. 3016800011. Earlier standard dipstick 24-038-06-s superseded to 124-755-121-S kit which includes the 24-038-10-s Dipstick and three Dipstick tubes to fit all CH Twin configurations.

****Can be used in place of the 1" diameter metal oil fill/dipstick tube for improved seal. Can be used with standard metal canister style mufflers. Do not use on applications with crossover manifolds.



EXTENDED OIL FILL KIT

Kit No.	Models
17-755-33-S	CH270-CH440



OIL DRAIN VALVE KIT

Item #	Kit No.	Drain Hole
1	25-755-14-S	3/8" - 18 NPTF, incl. 25-173-14-S cap
2	25-462-12-S*	3/8 - 18 NPTF x 2"
--	25-462-13-S	3/8 - 18 NPTF x 3"

*Will not fit 824cc engine due to interference fit.

EXHAUST

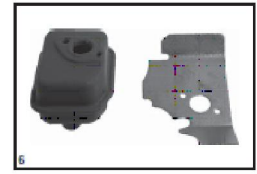
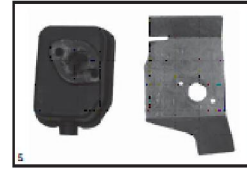
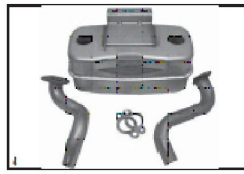
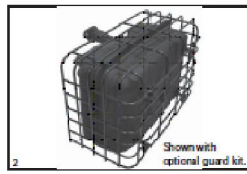

CS4-6 MUFFLER

Item	Part No.	Outlet Location	Outlet O.D.	Muff. Lgth.	Tube Lgth.	Models
1	63 786 01-S	Throttle Side*	1.0"	9.46"	1.0"	CS4-6

*Outlet is on opposite side of standard muffler location. Also allows for unobstructed PTO Face.

COURAGE TWIN (SV710-840) AND 7000 SERIES (KT715-745) MUFFLER

Item	Kit No.	Muffler Only	Engine Side
4	32 786 01-S	32 068 01-S	Bottom/Toward Oil Filter

COURAGE SINGLE (SV470-620) MUFFLER

Item	Part No.	Description	Engine Side	Outlet D.B.C
2	20 786 02-S***	Muffler Kit	Starter	2.047
2	20 755 10-S	Guard Kit*		
2	12 755 107-S	Guarg Kit**		

*Cage open at bottom to avoid interference with deck.

**Cage closed at bottom

***Not compliant for California

****California Compliant Muffler

XT (COURAGE) MUFFLER KIT

Kit includes Muffler and heat Deflector

Item	Part No.	Choke Type	Outlet Location/Direction
5	14 068 01-S	Manual/Primer	Front Discharge
6	14 068 08-S	Manual/Primer	Side Discharge
--	14 068 05-S	Auto	Front Discharge
--	14 068 07-S	Auto	Side Discharge

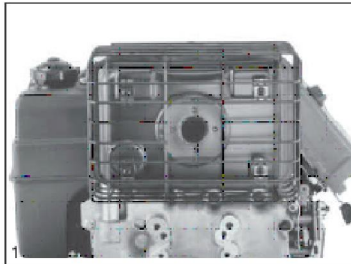

Includes Exhaust Deflector (not shown)

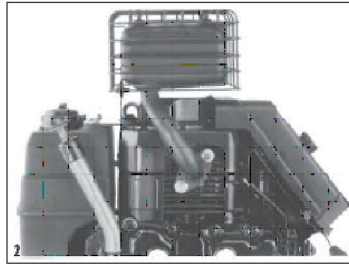

Includes Exhaust Deflector (not shown)

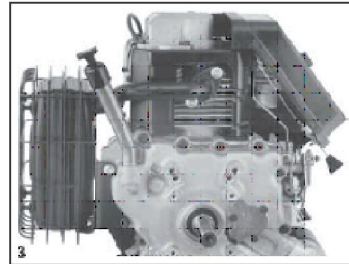

Vertical Orientation

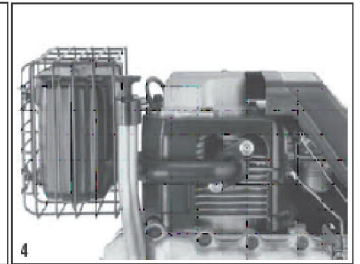

Horizontal Orientation

PILLOW MUFFLERS & GUARDS - (CH11-15)

Muffler kits include oil fill tube/dipstick as pictured . . . to avoid interference with muffler or guard . . . including sealant and a driver to aid in installation. Mufflers have stand offs for attaching optional wire guard. Guard kits do not include muffler.

Part No.	Muff. Only	Description	Engine Side	Outlet D.B.C	A	B	C	D	E	F	G	H	Item
12 786 09-S*	12 068 26-S	Muffler Kit	PTO	2.047"	13.0"	—	7.0"	—	5.0"	—	4.25"	—	1
12 786 13-S**	12 068 38-S	Muffler Kit	PTO	2.047"	13.0"	—	7.0"	—	5.0"	—	4.25"	—	1
12 755 107-S	—	Guard Kit	PTO	—	—	13.5"	—	6.25"	—	5.5"	—	5.0"	1
12 786 08-S*	12 068 25-S	Muffler Kit	Top	2.047"	17.0"	—	13.25"	—	4.5"	—	—	—	2
12 786 12-S**	12 068 39-S	Muffler Kit	Top	2.047"	17.0"	—	13.25"	—	4.5"	—	—	—	2
12 755 107-S	—	Guard Kit	Top	—	—	17.75"	—	13.125"	—	5.0"	—	—	2
12 786 10-S*	12 068 27-S	Muffler Kit***	Starter, No Tank	2.047"	8.0"	—	1.0"	—	11.0"	—	—	—	3
12 786 14-S**	12 068 41-S	Muffler Kit***	Starter, No Tank	2.047"	8.0"	—	1.0"	—	11.0"	—	—	—	3
12 786 11-S*	12 068 23-S	Muffler Kit	Starter, No Tank	2.047"	13.0"	—	7.0"	—	10.0"	—	—	—	4
12 786 15-S**	12 068 40-S	Muffler Kit	Starter, No Tank	2.047"	13.0"	—	7.0"	—	10.0"	—	—	—	4
—	**12 068 30-S	**Muffler****	Starter, No Tank	2.047"	13.0"	—	7.0"	—	10.0"	—	—	—	4
12 755 107-S	—	Guard Kit	Starter, No Tank	—	—	13.75"	—	6.25"	—	10.5"	—	—	4

* Muffler has no integral port liner. It is usable only on CH11-14 models below Serial No. 2628900001.

** Muffler has integral port liner extending from mounting flange, to interface with cored-out cylinder head. Only for models with Serial No. 2628900001 or higher, which include cored-out cylinder head.

*** Muffler kit not usable on specs with fuel pump.

**** For CH14 LP engines only; includes oxygen sensor port in manifold-to-muffler pipe.

A — Centerline of crank to top of muffler.

E — Centerline of crank to left edge of muffler.

B — Centerline of crank to top of guard.

F — Centerline of crank to left edge of guard.

C — Centerline of crank to bottom of muffler.

G — From PTO face to farthest edge of muffler.

D — Centerline of crank to bottom of guard.

H — From PTO face to farthest edge of guard.

PHONE (800) 569-2700

EXHAUST

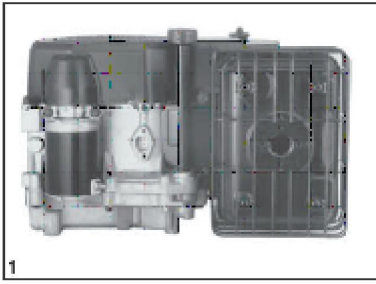

1 Vertical Orientation (Standard)

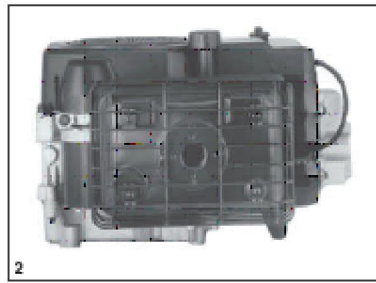

2 Horizontal Orientation

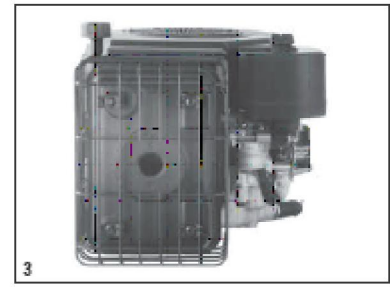

3 Valve Cover Orientation

PILLOW MUFFLERS & GUARDS - CV11-16 / CV460-493

Guard kits do not include muffler. **Note:** Mufflers 12 068 54-S and 55-S are exclusive to CV460-493, 12 068 39-S is also useable. No other mufflers are useable on these models.

Part No.	Description	Engine Stand Offs		Hardware (See note)	Outlet							Item
		Side	For Guard		D.B.C.	A	B	C	D	E	F	
12 068 21-S*	Muffler (Standard)	Starter	No	1	2.047"	12.0"	—	0.75"	—	4.5"	—	1
12 068 44-S**	Muffler (Standard)	Starter	No	1	2.047"	12.0"	—	10.75"	—	4.5"	—	1
12 068 54-S**	Muffler	Starter	No	1	2.047"	12.47"	—	10.75"	—	4.5"	—	1
12 068 23-S*	Muffler	Starter	Yes	1	2.047"	12.0"	—	10.75"	—	4.5"	—	1
12 068 40-S**	Muffler	Starter	Yes	1	2.047"	12.0"	—	10.75"	—	4.5"	—	1
12 068 30-S**	Muffler****	Starter	Yes	1	2.047"	12.0"	—	10.75"	—	4.5"	—	1
12 068 55-S**	Muffler	Starter	Yes	1	2.047"	12.47"	—	10.75"	—	4.5"	—	1
12 755 107-S	Guard Kit	Starter	—	—	—	—	12.5"	—	11.25"	—	5.25"	1
(12.97"/460-493)												
12 068 20-S*	Muffler***	Starter	No	2	2.047"	8.0"	—	9.25"	—	3.75"	—	2
12 068 42-S**	Muffler***	Starter	No	2	2.047"	8.0"	—	9.25"	—	3.75"	—	2
12 068 27-S*	Muffler***	Starter	Yes	2	2.047"	8.0"	—	9.25"	—	3.75"	—	2
12 068 41-S**	Muffler***	Starter	Yes	2	2.047"	8.0"	—	9.25"	—	3.75"	—	2
12 755 72-S	Guard Kit	Starter	—	—	—	—	8.5"	—	9.75"	—	4.25"	2
12 068 25-S*	Muffler	Valve	Yes	3	2.047"	2.5"	—	10.5"	—	—	—	3
12 068 39-S**	Muffler	Valve	Yes	3	2.047"	2.5"	—	10.5"	—	—	—	3

* Muffler has no integral port liner. It is useable only on CV11-14 models below Serial No. 2628900001.

** Muffler has integral port liner extending from mounting flange, to interface with cored-out cylinder head. Only for models with Serial No. 2628900001 or higher, which include cored-out cylinder head.

*** Muffler not useable on specs with fuel pump.

**** For CV14 LP engines only; includes oxygen sensor port in manifold-to-muffler pipe.

Note: for mufflers 12 068 25-S and 12 068 39-S, only guard 12 755 107-S is necessary for EEC. Mufflers 12 068 20-S, 12 068 21-S, 12 068 42-S and 12 068 44-S do not have weld nuts for guard attachment, so they cannot be made EEC-compliant.

A — Centerline of crank to right edge of muffler. B — Centerline of crank to right edge of guard. C — Mounting surface to top of muffler.

D — Mounting surface to top of guard. E — Centerline of oil fill cap to outer edge of muffler. F — Centerline of oil fill cap to outer edge of guard.

Mounting Hardware (if not presently on engine)

1 - Order (1) 12 126 71-S bracket, (2) M-645025-S screw, (1) M-545016-S screw, (2) M-841080 nut, (1) X-25-78-S washer. (2) 12 112 20-S spacer (sheet metal valve cover only).

2 - Order 12 755 30-S mounting kit.

3 - Order (1) 12 126 56-S bracket, (2) M-645025-S screw, (2) M-645015-S screw, (1) 12 041 03-S gasket, (2) M-841060-S nut, (2) 12 112 20-S spacer (sheet metal valve cover only).

KOHLER

COMMAND PRO HORIZONTAL MUFFLER

Kit No.	Description	Models	Item
17 086 31-S	Low Profile	CH270	---
17 068 38-S	Low Profile	CH395	---
17 068 40-S	Low Profile	CH440	1



EXHAUST

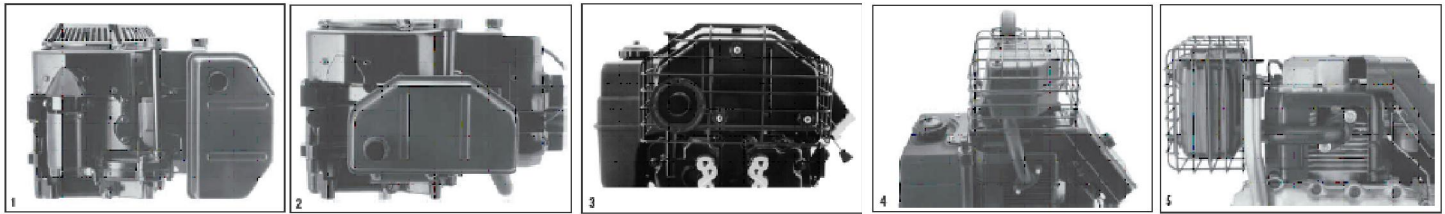

HAM CAN MUFFLERS - CH/CV11-15

CV Models

Part No.	Description	Outlet O.D.	A	Side	Item
12 068 01-S	Muffler	1.25"	4.94"	Starter	1
12 786 18-S	Mounting Kit*	—	—	Starter	1
12 068 03-S	Muffler	1.25"	6.5"	Starter	2
12 068 35-S	Muffler**	1.25"	.5"	Starter	2
12 755 30-S	Mounting Kit*	—	—	Starter	2

A — Extends away from blower housing.

* Includes bracketry, gasket, hardware.

**Identical to the -03 muffler, but includes integral port liner extending from themounting flange. Only ham can muffler usable on CV11-15 models withcored-out cylinder head, Serial No. 26289000001 and higher

CH Models

Part No.	Description	Outlet D.B.C.	Space	Side	Item
12 068 11-S	Muffler only**	2.047"	B	PTO	3
12 786 04-S	Mounting Kit ***	—	—	PTO	3
12 755 26-S	Guard Kit	—	B	PTO	3
12 068 11-S	Muffler only**	2.047"	C	Top	4
12 786 03-S	Mounting/Guard Kit****	—	C	Top	4
12 068 11-S	Muffler only	2.047"	D	Starter	5
12 786 02-S	Mounting Kit***	—	—	Starter	5
12 755 26-S	Guard Kit	—	D	Starter	5

** Shown with deflector, not included.

*** Includes manifold, bracketry, gaskets, hardware.

****Includes manifold, bracketry, exhaust deflector, gasket, guard, hardware.

B — From centerline of crank to top of muffler is 12.5"; to top of guard is 13"; to bottom of guard is 6". From PTO face to guard at farthest point is 5.5"; to muffler is 5".

C — From centerline of crank to top of guard is 18.5"; to top of deflector is 20.55".

D — From centerline of crank to left edge of guard is 11.25"; to left edge of muffler is 10.75

MISCELLANEOUS MUFFLERS -

CV Models

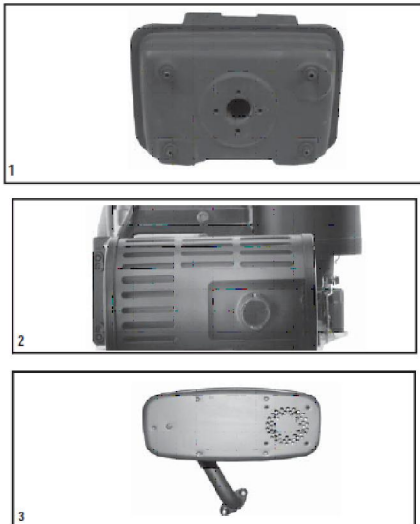

CH Models

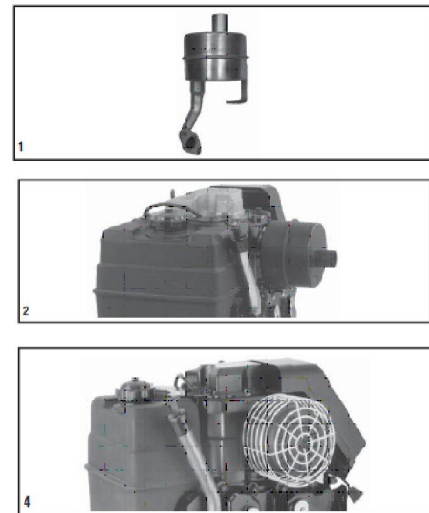

Part No.	Description	Engine Side	Outlet O.D.	Item
12 068 57-S*	Muffler	Valve Cover	1.25"	1
12 755 20-S**	Muffler Kit	Valve Cover	1.25"	2
12 068 49-S***	Muffler	Valve Cover	1.125"	3

* Includes integral heat shield and exhaust deflector. Also order (2) M-841080 nut, (1) 12 041 03-S gasket, (1) 25 086 16-S screw, (1) X-25-95-S spacer, (1) X-20-1-S lock washer, (1) 25 100 20-S nut.

Muffler extends 5.625" from valve cover. (1) M-645025-S screw, (1) 12 112 20-S spacer (if engine has stamped steel valve cover).

** Includes integral guard. Muffler extends 7" from blower housing.

***Also order (1) 12 041 03-S gasket, (2) M-841060-S nuts, (1) 12 126 85-S bracket, (2) 12 112 20-S spacers, (4) M-645016 screws, and (2) M-645025 screws.

Kit No.	Muff. Only	Description	Side	Item
12 786 16-S*	12 068 58-S&	Round	Top	1
12 786 20-S	12 068 51-S	Round	Above PTO	2
12 314 32-S	—	Guard for 1 & 2	—	--
12 786 05-S**	275679-S	Pepperpot	Above PTO	4
25 314 01-S	—	Guard only	—	4

* Includes angled oil fill tube and dipstick to clear muffler, plus mounting bracketand hardware. Muffler outlet is 5.5" above valve cover. Outlet O.D. is 1.25".

**Includes muffler, manifold, gasket, hardware. Muffler has 1.0" N.P.T. internal thread. Not usable if engine requires CARB/EPA certification. & Aluminized steel canister.

PHONE (800) 569-2700

EXHAUST - LV625-680, CV17-26 / 730-750



Shown: 24 068 27-S Quiet version.
(Mufflers will fit with top-mount controls only.)

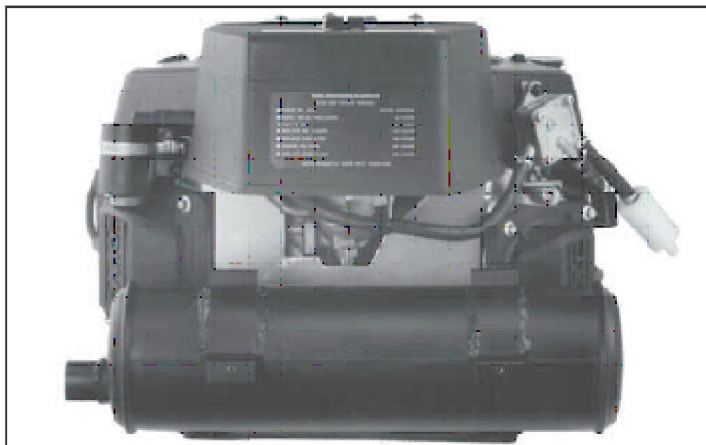

Shown: 24 068 27-S Quiet version.
(Mufflers will fit with top-mount controls only.)

COMMERCIAL MOWER CANISTER MUFFLERS — HEAT SHIELDS REQUIRED - SEE BELOW.

Part No.	Outlet Location/Direction	Outlet	Muffler	Muffler	A	B	Model
		O.D.	Dia.	Length			
24 068 09-S	Starter Side/Straight	1.375"	4.0"	12.0"	1.0"	4.75"	CV17-25/730,740,750,LV625-680
24 068 08-S	Filter Side/Straight	1.375"	4.0"	12.0"	1.0"	4.75"	CV17-25/730,740,750,LV625-680
24 068 20-S	Filter Side/Down	1.375"	4.0"	12.0"	1.0"	4.75"	CV17-25/730,740,750,LV625-680
24 068 21-S	Filter Side/Extended	1.375"	4.0"	12.0"	1.0"	4.75"	CV17-25/730,740,750,LV625-680

*Same as 24 068 08-S, but outlet is higher on end cap to clear obstructions.

&Aluminized steel canister.

QUIET CANISTER MUFFLERS — HEAT SHIELDS REQUIRED. SEE BELOW.

These mufflers are larger than those above, and also up to 4 dBA quieter (@3600 RPM, WOT).

Kit No.	Part No.	Outlet Location/Direction	Outlet	Muffler	Muffler	A	B	Model
			O.D.	Dia.	Length			
-----	24 068 25-S	Center/Straight	1.375"	4.62"	16.0"	1.0"	5.5"	CV17-25/730,740,750,LV625-680
-----	24 068 27-S	Starter Side/Straight	1.375"	4.62"	16.0"	1.0"	5.5"	CV17-25/730,740,750,LV625-680
-----	24 068 29-S	Filter Side/Straight	1.375"	4.62"	16.0"	1.0"	5.5"	CV17-25/730,740,750,LV625-680
-----	24 068 28-S	Filter Side/Down	1.375"	4.62"	16.0"	1.0"	5.5"	CV17-25/730,740,750,LV625-680
-----	24 068 26-S	Filter Side/Extended	1.375"	4.62"	16.0"	1.0"	5.5"	CV17-25/730,740,750,LV625-680
-----	24 068 58-S	Filter Side/Straight	1.375"	4.62"	16.0"	1.0"	5.5"	CV17-25/730,740,750,LV625-680
-----	24 068 43-S	Center/Straight	1.375"	4.62"	16.0"	1.0"	5.5"	CV26/745EFI, ECV630-749
24 786 28-S	24 068 45-S	Starter Side/Straight	1.375"	4.62"	16.0"	1.0"	5.5"	CV26/745EFI, ECV630-749
24 786 29-S	24 068 47-S	Filter Side/Straight	1.375"	4.62"	16.0"	1.0"	5.5"	CV26/745EFI, ECV630-749
24 786 30-S	24 068 46-S	Filter Side/Down	1.375"	4.62"	16.0"	1.0"	5.5"	CV26/745EFI, ECV630-749

A — Mounting surface to bottom of muffler.

B — Mounting surface to top of muffler.

Note: For mounting, order (2) 24 041 49-S gasket, (2) 24 072 08-S stud, (2) M-641060-S nut, (4) M-841080-S nut

KOHLER



HEAT SHIELDS FOR CANISTER MUFFLERS

Kohler requires a heat shield between muffler and air cleaner.

Part No.	Designed for Mufflers
24 281 06-S*	24 068 08-S, 09-S, 20-S, 21-S
24 281 51-S*	24 068 26-S, 27-S, 28-S, 29-S
24 281 14-S*	24 068 25-S
24 281 15-S*	24 068 44-S, 45-S, 46-S, 47-S

*Order (4) 25 086 40-S screws for mounting heat shield.

‡Aluminized steel to match muffler.

EXHAUST - LH640-775, CH18-26 / CH730-750

KOHLER AEGIS

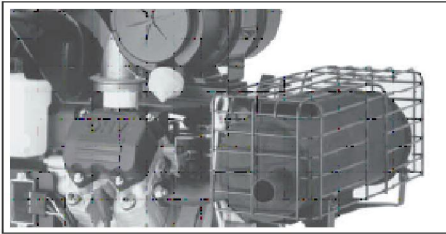

KOHLER COMMAND

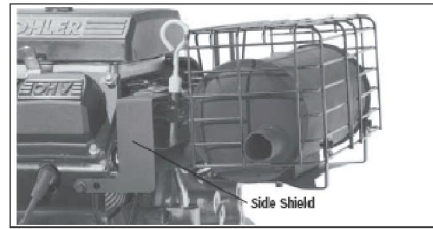

STANDARD PTO-CANISTER MUFFLER & GUARD KITS

(not usable with 1" dia. metal oil fill tube)

Kit No.	Muff. Only	Outlet Location/ Direction	Outlet O.D.	AEGIS		COMMAND		Model
				A	B	A	B	
24 786 04-S	24 068 05-S	Center/Straight	1.25"	—	—	4.5"	10.5"	CH18-22
24 786 05-S	24 068 07-S	Filter Side/Straight	1.25"	—	—	4.5"	10.5"	CH18-22
24 786 06-S	24 068 06-S	Starter Side/Straight	1.25"	—	—	4.5"	10.5"	CH18-22
24 786 23-S*	—	Starter Side/45° Down	1.25"	4.3"	10.3"	4.5"	10.5"	CH18-22, CH25/730-740, LH640-755
24 786 10-S**	24 068 12-S	Center/Straight	1.25"	4.3"	10.3"	4.5"	10.5"	CH25/730,740,750, LH640-755
24 786 11-S**	24 068 18-S	Filter Side/Straight	1.25"	4.3"	10.3"	4.5"	10.5"	CH25/730,740,750, LH640-755
24 786 12-S**	24 068 59-S&	Starter Side/Strt (Shown)	1.25"	4.3"	10.3"	4.5"	10.5"	CH25/730,740,750, LH640-755
24 786 26-S	24 068 57-S&	Filter Side/Straight	1.25"	4.3"	10.3"	4.5"	10.5"	CH25/730,740,750, LH640-755
24 755 80-S***	—	Muffler Guard Kit	—	—	—	—	—	CH18-26/730-750, LH640-775, ECH630-749
24 755 114-S***	—	Side Shield Kit (2 Shields)	—	—	—	—	—	CH18-26/730-750 only (not LH) ECH630-749
24 786 32-S	24 068 35-S**%	Filter Side/Straight	1.25"	4.3"	10.3"	4.5"	10.5"	CH26/745, LH775
24 786 33-S	24 068 41-S**%	Center/Straight	1.25"	4.3"	10.3"	4.5"	10.5"	CH26/745, LH775
24 786 31-S	24 068 42-S*%	Starter Side/Straight	1.25"	4.3"	10.3"	4.5"	10.5"	CH26/745, LH775

*CH25,26/730-750,LH640-775 **require** heat shield. See shields below. **Includes heat shield and screws. See shields below.

***When guard kit 24 755 80-S and shield kit 24 755 114-S are used together, they meet EEC (European) standards for avoidance with hot surfaces.

%25 755 36-S mounting kit required for first time installation. &Aluminized steel canister.

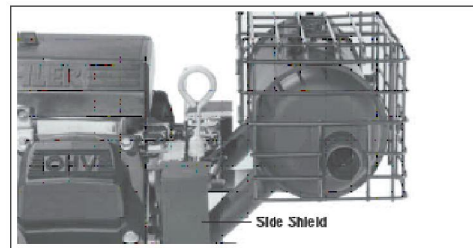
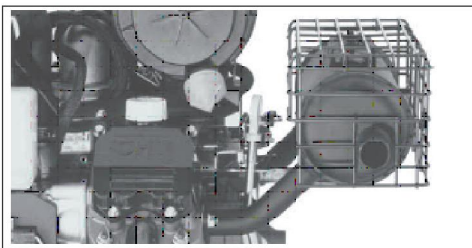

PTO-CANISTER MUFFLER & GUARD KITS (IDEAL FOR GEN SETS)

Mufflers are same size as standard canisters (top of page), but have a raised body to clear the alternator assembly on a generator set. Note that there is no center outlet muffler because it would allow hot exhaust to blow directly at the gen set control box

Kit No.	Muff. Only	Outlet Location/ Direction	Outlet O.D.	AEGIS		COMMAND		Model
				A	B	A	B	
24 786 21-S*	24 068 36-S	Filter Side/Straight	1.25"	6.3"	13.1"	6.5"	13.25"	CH18-25/730,740,750, LH640-755
24 786 22-S*	24 068 37-S	Starter Side/Straight	1.25"	6.3"	13.1"	6.5"	13.25"	CH18-25/730,740,750, LH640-755
24 786 27-S	24 068 51-S	Filter Side/Straight	1.25"	6.3"	13.1"	6.5"	13.25"	CH26/745, LH775, ECH630-749
25 785 02-S	24 068 60-S	Starter Side/Straight	1.25"	6.3"	13.1"	6.5"	13.25"	CH26/745, LH775, ECH630-749
24 755 104-S**	—	Muffler Guard Kit	—	—	—	—	—	CH18-25/730-750, LH640-775
24 755 114-S**	—	Side Shield Kit (2 Shields)	—	—	—	—	—	CH18-25/730-750 only (not LH)

* Includes only screws for attaching heat shield. See shields below. (Required for CH25,26/730-750,LH690-775.)

** When guard kit 24 755 104-S and shield kit 24 755 114-S are used together, they meet EEC (European) standards for avoidance with hot surfaces.

A - Centerline of crank to bottom of muffler. B - Centerline of crank to top of muffler.

PHONE (800) 569-2700

EXHAUST

VERTICAL MUFFLER KITS* (CV17-740,750)

Kit No.	Muff. Only	Location	Outlet	A	B	Item
24 786 13-S	24 068 19-S	Starter Side	3.06"	3.0"	3.5"	1 (Shown)
24 786 14-S	24 068 19-S	Filter Side	3.06"	3.0"	3.5"	1
24 786 15-S	24 068 22-S	Starter Side	3.06"	—	—	2 (Shown)
24 786 16-S	24 068 22-S	Filter Side	3.06"	—	—	2

*Includes muffler, manifold, brackets, heat deflector, clamp, gaskets, and hardware.

A — Extends forward of air cleaner. B — Extends right (or left) of valve cover.

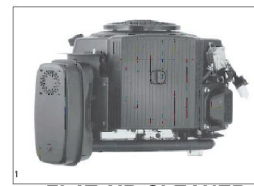

FLAT AIR CLEANER

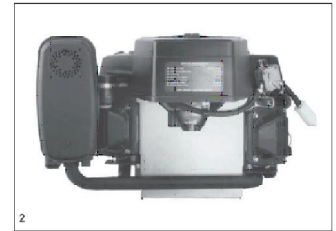

COMMERCIAL MOWER AIR CLEANER

CONFIDANT AND 7000 SERIES MUFFLER KTIS

Kit No.	Muff. Only	Description	Item
32 786 03-S	16 068 02-S	Oil Filter Side	1
32 786 05-S	16 068 01-S	Starter Side	2
32 786 04-S		Horizontal Canister	3
32 786 06-S		Horizontal Canister*	3

*For wright Mowers

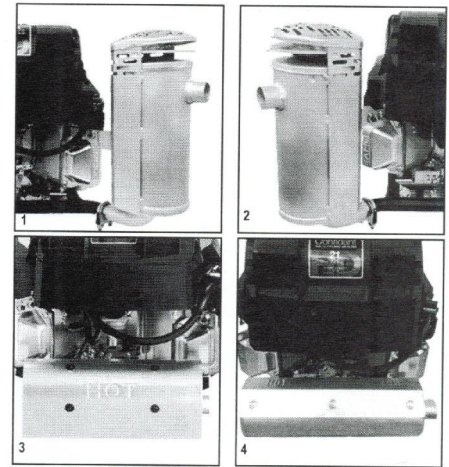

KOHLER

EXHAUST - CH / CV 940-980, ECV940-980

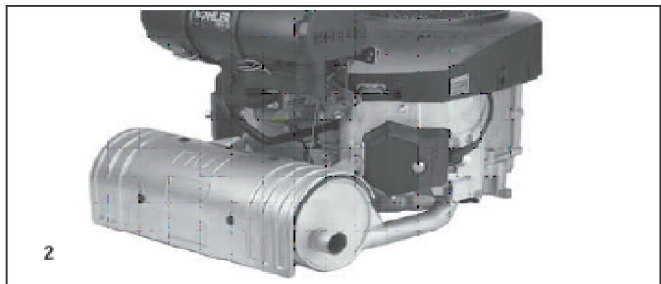
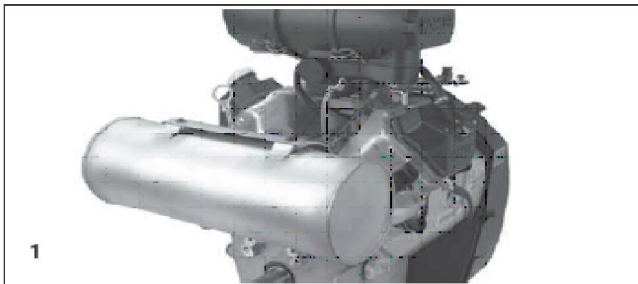

HORIZONTAL MUFFLER KITS*

Kit No.	Muff. Only	Discharge Outlet	O.D.	A	B	Item	Heat Shield (required)
62 786 01-S	62 068 06-S	Center	1.5"	11.75"	4.0"	1	62 314 05-S
62 786 02-S	62 068 05-S	Starter Side	1.5"	11.75"	4.0"	1	62 314 05-S
62 786 03-S	62 068 02-S	Opposite Starter	1.5"	11.75"	4.0"	1	62 314 05-S

*Includes muffler, gaskets, heat shield, and hardware.

A — Centerline of crank to top of muffler. B — Centerline of crank to bottom of muffler.

VERTICAL MUFFLER KITS*

Kit No.	Muff. Only	Discharge Outlet	O.D.	A	B	Item	Heat Shield (required)
62 786 04-S	62 068 09-S	Center	1.5"	2.68"	4.04"	2	62 314 06-S
62 786 05-S	62 068 08-S	Starter Side	1.5"	2.68"	4.04"	2	62 314 04-S
62 786 06-S	62 068 07-S	Opposite Starter	1.5"	2.68"	4.04"	2	62 314 04-S

*Includes muffler, brackets, gaskets, heat shield, and hardware.

A — Mounting surface to bottom of muffler. B — Mounting surface to top of muffler.

FAX (800) 489-4804

EXHAUST - LH640-775, CH18-25 / CH730-750

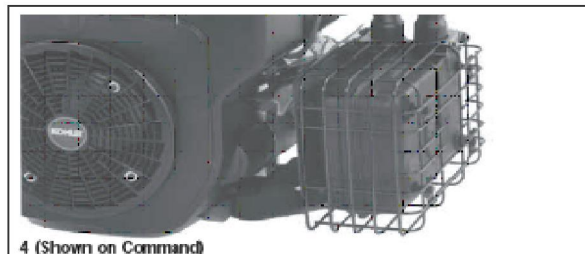
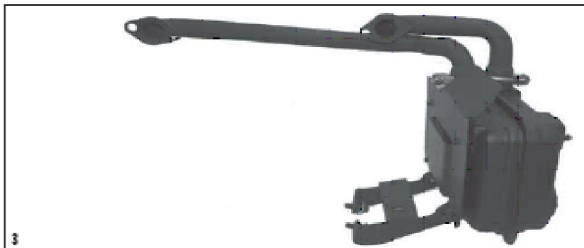
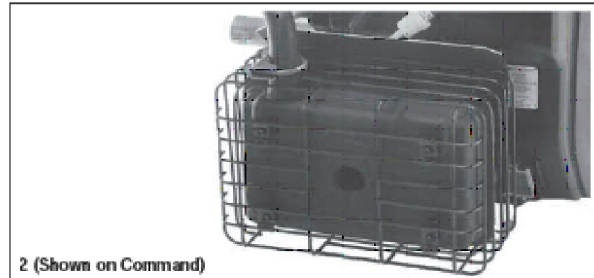

SIDE-MOUNT MUFFLER & GUARD KITS (STANDARD)

(not usable with 1" dia. metal or plastic oil fill tube)

Kit No.	Muff. Only	Location	Outlet D.B.C.	Extends Engine Model	Width By	Item
24 786 08-S	24 068 13-S	Starter Side	2.047"	CH18-22	4.0"	1
24 786 09-S	24 068 14-S	Filter Side***	2.047"	CH18-22*	4.0"	1 (Shown)
24 755 22-S	—	Guard Kit**	—	CH18-22*	4.375"	2
24 786 19-S	24 068 30-S	Starter Side	2.047"	CH25/730,740,750, LH640-755*****	4.25"	3 (Shown)
24 786 20-S	24 068 31-S	Filter Side****	2.047"	CH25/730,740,750, LH640-755*****	5.60"	3
24 755 149-S	— Guard Kit,	Starter Side	—	CH25/730-750, LH640-755	4.25"	4 (Shown)
24 755 151-S	— Guard Kit,	Filter Side	—	CH25/730-750, LH640-755	5.60"	4
24 786 24-S	24 068 54-S	Starter Side	2.047"	CH26,745 (Not for LH775)*****	4.25"	3
24 786 25-S	24 068 55-S	Filter Side****	2.047"	CH26,745 (Not for LH775)*****	4.25"	3

* Not usable on models with oil cooler.

** Shown on 24 786 09-S Muffler Kit (muffler not included).

*** May also need to order 12 050 14-S oil filter to avoid interference with muffler.

**** Includes 12 050 14-S oil filter to avoid interference with muffler.

*****Kits include muffler and dual manifolds

KOHLER

EXHAUST - LH640-775, CH18-25/730-750

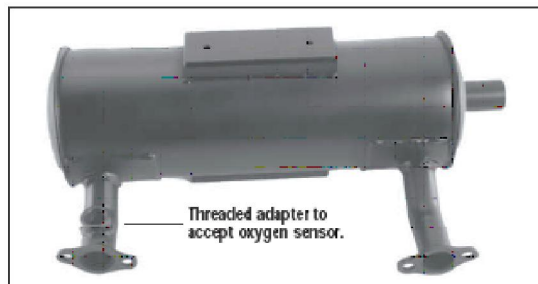

PTO CANISTER MUFFLERS & GUARD (Closed Loop LP Systems)

Mufflers include threaded adapter in filter-side inlet pipe, to accept oxygensensor for closed loop LP fuel systems.

Kit No.	Muff. Only	Location/ Direction	Outlet O.D.	Models
—	24 068 33-S*	Starter Side/Straight	1.25"	CH18-25,730
—	24 068 34-S*	Filter Side/Straight	1.25"	CH18-25,730
24 755 80-S	—	Wire Guard Kit	—	CH18-25,730

* Mufflers include brackets for attaching heat shield (required for CH25). Order 24 314 04-S heat shield and (4) M-650012-S screws.

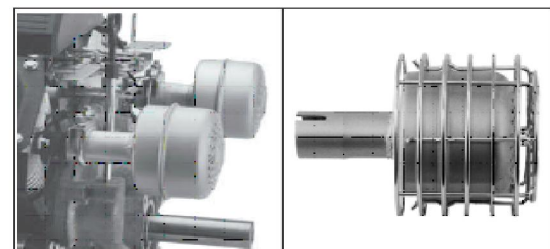

PEPPERPOT MUFFLER & GUARD

Muffler kit includes two mufflers, manifolds and gaskets, plus hardware. Muffler is not usable on engines that must meet CARB/EPA emission regulations, unless approved by Kohler for specific applications.

Part No.	Muffler Only	Description	Models
24 786 07-S	52 068 04-S	Muffler Kit	CH18-25/730-750, LH640-775
25 314 01-S	—	Guard (order 2)	CH18-25/730-750, LH640-775

PHONE (800) 569-2700

Throttle and Choke Shaft Repair Kits

For 1" Carburetors, determine which kit you need by measuring your throttle shaft as shown below.

There are two choke shaft repair kits.
25-757-20 is to repair 1/2" carburetors.
25-757-21 is to repair 1" carburetors.

1" Throttle Shaft Kit Numbers	Dimensions			
	A	B	C	D
25-757-14	.104"	.619"	1.227"	2.164"
25-757-15	.104"	1.416"	1.289"	3.00"
25-757-16	.104"	1.447"	1.227"	3.00"

Note: When repairing your carburetor with a throttle or choke shaft repair kit, Kohler recommends you also install a carburetor repair kit.

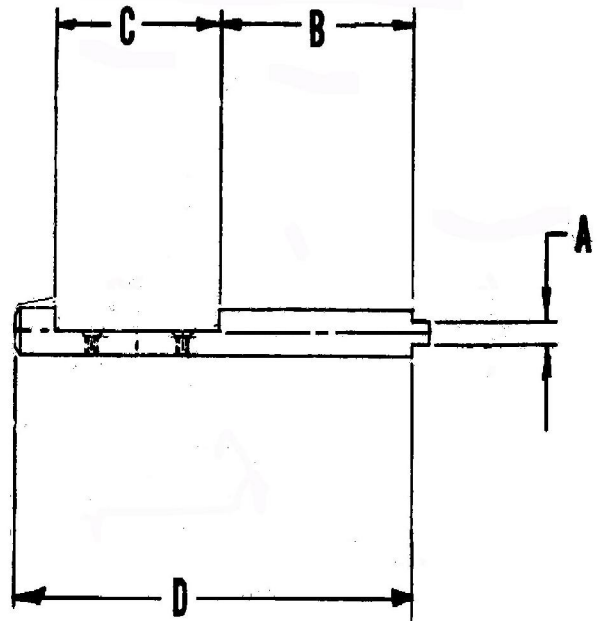

KOHLER

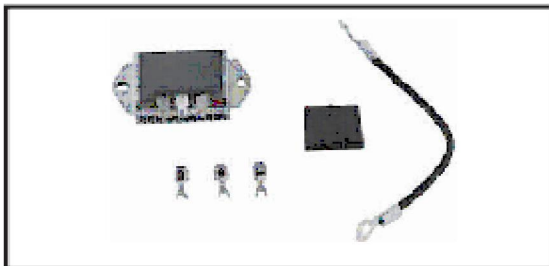

CHARGING SYSTEMS

Part No.	Description	Models
15 Amp 237878-S	Stator Kit	CH/CV11-16/460-493, SV470-620, CH/CV17-26/730-745, LH640-775, LV625-680,SV710-740
41 403 10-S	Rectifier-Regulator	All
25 Amp 28 085 02-S 54 755 03-S	Stator Kit Stator/Rect.Reg Kit*	CH/CV11-16/460-493, SV470-620 CH/CV17-26/730-745, TH520-575, LH640-775, LV625-675, SV710-740
24 755 144-S	Rectifier/Regulator** (Shown)	

*Converts 15 amp system to 25 amp

**Converts old 25 amp rectifier-regulator to new 25 amp rectifier-regulator on all models. Includes, rectifier-regulator, terminals, lead, connector block



ELECTRONIC IGNITION MODULES

Part No.	Description	Models
12 584 04-S	Ignition Coil (shown top)	CH11-15,CH410-450,CV11-15, CV430-493 (electric start models)
20 584 03-S	Ignition Coi	Courage SV470-SV620
24 584 36-S	Ignition Coil (shown bottom)	CH22-25,CH740-750,CV22-25, CV740-750,Courage SV735-740
24 584 45-S	Ignition Coil	CH18-23,CH620-730, CV17-23, CV620-730
25-707-03-S	Spark Adv DSAI	Conversion kit
52 584 02-S	Ignition Coil	Magnum M18-20,MV16-20

SERVICE MANUALS

BRIGGS & STRATTON

PART #	DESCRIPTION	RETAIL
CE8069	OUT OF PRODUCTION ENGINES 1919-1981	\$50.85
270962	SINGLE CLINDER 4 CYCLE	24.15
271172	V-TWIN 4 CYCLE ENGINE	25.10
272144	VANGUARD OHV V-TWIN AIR COOLED	25.10
272147	VANGUARD SINGLE CYLINDER OHV	23.95
273521	INTEK V-TWIN OHV	23.95
276781	SINGLE CYLINDER OHV MANUAL	23.95
275072	MICRO ENGINE REPAIR MANUAL	25.10
275429	VANGUARD OHV TWIN CYLINDER LIQUID COOLED	25.10
276535	2-CYCLE SNOW ENGINE REPAIR MANUAL	25.10
279000	SINGLE CYLINDER OHV 110000 120000	28.40
MS1055	VANGUARD OHV 3-CYL GAS LIQUID COOLED	34.85



KOHLER

PART #	DESCRIPTION	RETAIL
63-690-01	CS4-CS12.75 COMMAND SLANT CYLINDER	\$24.95
TP-2337-A	CH5, CH6 COMMAND HORIZONTAL	29.95
17-690-01	CH270, CH395, CH440 HORIZONTAL	24.95
TP-2402-A	CH11-CH16 COMMAND HORIZONTAL	29.95
12-690-01	CV11-16, CV460-495 COMMAND VERTICAL	29.95
TP-2580	CH940-980 COMMAND HORIZONTAL	24.95
24-690-07	CV17-CV750 COMMAND VERTICAL	29.95
62-690-02	CV940-CV1000 VERTICAL	24.95
14-690-01	COURAGE XT-6, XT-7	29.95
24-690-01	ECH630-749, CH26, CH735, CH745 HORIZONTAL	29.95
24-690-02	ECV630-749, CV26, CV735, CV745 VERTICAL	24.95
TP-2509	LV560-675 AEGIS SERIES VERTICAL SHAFT	29.95
TP-2527-A	LH630-750 AEGIS SERIES HORIZONTAL	24.95
66-690-07	LH775 AEGIS SERIES HORIZONTAL	24.95
TP-2203-A	M8-M16 MAGNUM HORIZONTAL	29.95
TP-2204-B	M18-M20 MAGNUM HORIZONTAL	29.95
TP-2289-A	MV16-MV20 MAGNUM VERTICAL	29.95
TP-2043-A	KT & KTII SERIES, KT17 - KT21	29.95
TP-2379	K91-K341 K SERIES	29.95
TP-1288	K361 K SERIES	29.95
ENS-607	K482 - K662 K SERIES TWIN	24.95
18-690-01	SH265 HORIZONTAL SERVICE MANUAL	24.95
20-690-01	SV470-620 COURAGE SINGLE CYLINDER	29.95
32-690-01	SV710-SV840 COURAGE TWIN CYLINDER	29.95
TP-2480	TH16 - TH18 TRIAD OHC HORIZONTAL	29.95



TECUMSEH

PART #	DESCRIPTION	RETAIL
740045	PEERLESS TRANSAXLES & DRIVE PRODUCTS	\$10.35
740047	2 CYCLE AH520-600, AV520-600, HSK600, TVS600	\$ 9.67
	TECUMSEH MANUAL SUBJECT TO AVAILABILITY!	



PHONE (800) 569-2700

**TRY IT
TODAY!!!!!!**

Mo-Deck

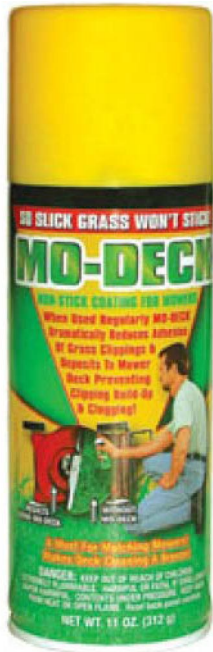

A polymere spray that adheares to the mower decks, blades, snowblower, snowshovels or ATV'S and Dirt Bikes. Builds up over time, the more you use, the better it gets. Now clean up is a breeze and your equipment will run more efficiently, too.

Simple to apply, shake and spray, convenient for larger deck areas
 Ready to use in less than 10 minutes after spraying
 Creates a slick, non-stick surface, ideal for build-up areas
 Reduces mechanical wear and can extend operating life of products
 Will not attract or hold dirt or dust
 Proudly made in the USA, in use for over 10 years!

PART #	DESCRIPTION	RETAIL
MO-DECK	16 oz Spray Can	\$ 7.95

MISCELLANEOUS
LINES

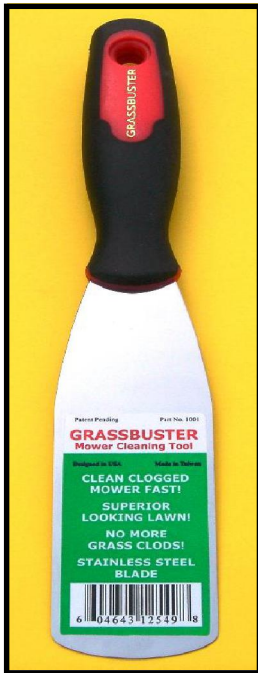

THE GRASSBUSTER!

Though this tool looks suspiciously like a regular spatula repurposed for lawnmower duty,

IT IS NOT!!

Specifically designed to clean debris from the underside of a mower deck, it has a durable 2" wide stainless-steel blade that has been taper ground along its 5" length for flexibility, allowing it to quickly conform to the underside of a mower deck. The blade corners have also been rounded to prevent scratches.

Well made in the USA!

This tool is simple yet effective
 (and superior to a screwdriver!)
 for removing caked-on grass



PART # GB-R
RETAIL - \$9.95

FAX (800) 489-4804

AmerSeal

PART #	DESCRIPTION	RETAIL
AS8	8 oz. bottle	\$ 5.25
AS16	16 oz. bottle	\$ 10.25
AS32	32 oz. bottle	\$ 11.50
AS1	1 gallon jug w/ pump	\$ 55.00
AS5	5 gallon pail	\$175.00
AS5P	5 gallon pump	\$ 70.00

Amerseal is a scientifically developed preventive maintenance chemical compound. It is a premium heavy duty tire sealant for commercial and industrial tires that are subject to heavy use.

Amerseal is installed quickly and easily through the valve stem with our injection pump without deflating the tire. The tire is protected against leaks for the remainder of its life. A puncture that occurs while driving will seal almost instantly and very little air is lost.

Amerseal will permanently seal tread area up to 1/4" and maintain proper inflation. By maintaining proper inflation, the tire will generate less heat and friction so it will last longer. It is easy to use with no special mixing or preparation needed. Also, Amerseal is fluid and effective in temperatures down to 30 degrees below zero.



- **Whip Prevents And Stops Corrosion And Oxidation Of Battery Posts And Cables***
- **Whip Is Simple And Easy To Apply Using The Applicator Brush Which Is Furnished***
- **Clean Up Of Previous Corrosion Is NOT Necessary Unless Desired***
- **Whip Stops Corrosive Action On Contact***

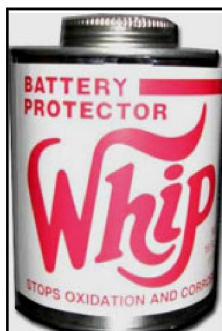

PART #	RETAIL
24-OZWHIP	\$4.99
2 OZ. BOTTLES FOR COUNTER DISPLAY	
24 BOTTLES IN A DISPLAY PACK	

PHONE (800) 569-2700

MISCELLANEOUS LINES



Heavy Duty Tire Repair Kit

Nealey Company produces high quality tubeless tire repair kits that plug the hole and patch the inside of the tire quickly, permanently, and easily. Our Tire Repair Kits include a non-bending, break-resistant insertion tool and non-tearing repair strands made of synthetic rubber containing no glue or cement.

How Nealey Tire Repair Kits Work

The secret to the Nealey Tire Repair Kit is the repair strand designed to last for years. The Nealey Tire Repair Kit repair strand is a cord consisting of uncured butyl and silicone rubber products that cure into the puncture, plugging the hole and forming a seal on both the inside and outside of the tire.

1. Insert unthreaded tool into puncture and rock vigorously to clean hole
2. Thread repair cord through eye of inserting tool until ends are even
3. Insert tool into puncture all the way to handle, then turn 1-1/2 revolutions.
4. Pull tool out until top just clears tire surface. Cut exposed cord to free tool.

Hole is now plugged and a patch-like repair remains on the inside.

Part # 11007 -- MINI TIRE REPAIR KIT

Contains - Ten 7-inch repairs and inserting tool
Repairs 2 and 4 ply tires on autos, small pickups, motorcycles, ATV's, golf cars, graden tractors, riding mowers, etc.
RETAIL - \$13.95

Part # 01007 -- REPAIR ONLY KIT

Contains - Ten (10) 7-inch repairs only
RETAIL - \$11.95

Part # 21014 -- MINI TIRE REPAIR KIT

Contains - Ten 14-inch repairs and inserting tool
Repairs 6 ply and larger tires on pickups, skid loaders, back hoes, graders, dump trucks, semis, tractors, combines, wagons, trailers, etc.
RETAIL - \$17.95

Part # 01014 -- REPAIR ONLY KIT

Contains - Ten (10) 14-inch repairs only
RETAIL - \$14.95

*Will patch
40 car
or mower
tires!!*

Part # 02014 -- REPAIR ONLY KIT

Contains - Twenty (20) 14-inch repairs only
RETAIL - \$19.95



MISCELLANEOUS
LINES



LINSEAL saves you money by eliminating:

- *Puncture repair costs
- *Repair call out charges
- *Immobility and downtime
- *Rim leaks

LINSEAL:

- *Coats tire interior
- *Forms strong air-tight seal
- *Seals holes up to 3/8"
- *Has multi-sealing capacity
- *Is a fiber-free product

PART #	DESCRIPTION	RETAIL
LS-.5	1/2 LITER BOTTLE w/ Applicator	\$ 8.85
LS-1	1 LITER BOTTLE w/ Applicator	\$ 12.99
LS-25	25 LITER PAIL	\$245.95
LS-PUMP	PUMP FOR 25 LITER PAIL	\$ 69.99



Did You Know?

Fluid Film® Stops Rust On Contact and Won't Let It Continue!

Fluid Film® Never Dries Out Or Evaporates

Fluid Film® Penetrates & Lubricates... Loosens Frozen Nuts From Bolt

Environmentally Friendlier... Contains NO Solvents, VOC, CFC's or Silicone

Fluid Film® Comes In Different Viscosities For More Difficult Rust Problems

Fluid Film® Products Have Unique Advantages Over Conventional Hard Coatings & Other Types of Soft Coating

PART #	DESCRIPTION	RETAIL
FFB	8 ounce Can with Brush	\$ 6.49
FF12	Fluid Film Spray Can	\$ 7.95
FFG	1 Gallon Can	\$34.95

PHONE (800) 569-2700

MISCELLANEOUS LINES



The Universal Push-Button Trimmer Head!!

Just push button, insert line
and you're ready to cut



PART #	DESCRIPTION	RETAIL
17038	Fits Curved and Straight Shaft trimmers	\$27.99

Fits most trimmers, comes with several different adapters. Holds .080 to .130 trimmer line.



TRIMMER LINE



PART #	DESCRIPTION	RETAIL
ROUND POWER PRO - round line with a break-resistant core		
High Performance, Co-extruded line featuring a tough abrasion skin		
60C3120	1 Lb. / .080 / 367 feet / Round	\$14.54
60C3124	1 Lb. / .095 / 255 Feet / Round	\$14.54
60C3224	3 Lb. / .095 / 767 Feet / Round	\$41.24
PENTA PRO - 5-sided line with a break-resistant core		
High Performance, Co-extruded line featuring a tough abrasion skin		
60C2120	1 Lb. / .080 / 400 Feet / Penta-Line	\$14.78
60C2124	1 Lb. / .095 / 282 Feet / Penta-Line	\$14.78
60C2130	1 Lb. / .118 / 180 Feet / Penta-Line	\$14.78
NYLIUM LINE - star or square line for demanding trimming tasks.		
Premium Nylium aluminum-particle additive. Extremely resistant to wear		
60C5095	1 Lb. / .095 / 298 Feet / Nylium Star Line	\$15.50
60C5105	1 Lb. / .105 / 226 Feet / Nylium Star Line	\$15.50
60C6095	3 Lb. / .095 / 810 Feet / Nylium Square Line	\$40.53



ROUND POWER PRO LINE



PENTA PRO NYLON LINE



NYLIUM® STAR LINE



MISCELLANEOUS LINES

FAX (800) 489-4804

GLOVES FOR THE WORKING MAN (and woman)!!



NT370



C4005



CRG23



C2354

TOUGH & DURABLE

PART#	DESCRIPTION	RETAIL
NT370S	Small Nitrile Work Glove	\$ 6.49
NT370M	Medium Nitrile Work Glove	\$ 6.49
NT370L	Large Nitrile Work Glove	\$ 6.49
NT370XL	X-Large Nitrile Work Glove	\$ 6.49
C4005M	Medium Insulated Nitrile Work Glove	\$ 6.99
C4005L	Large Insulated Nitrile Work Glove	\$ 6.99
C4005XL	X-Large Insulated Nitrile Work Glove	\$ 6.99
CRG23M	Medium All Purpose Insulated Glove	\$24.95
CRG23L	Large All Purpose Insulated Glove	\$24.95
CRG23XXL	XX-Large All Purpose Insulated Glove	\$24.95
*R7782IM	Medium Camo Insulated Glove	\$18.95
*R7782IL	Large Camo Insulated Glove	\$18.95
*R7782IXXL	XX-Large Camo Insulated Glove	\$18.95
C2354L	Premium Grain Cowhide Driver L	\$15.99
C2354XL	Premium Grain Cowhide Driver XL	\$15.99
C2354XXL	Premium Grain Cowhide Driver XXL	\$15.99
C2354IL	Premium Grain Cowhide Insulated Driver L	\$17.99
C2354IXL	Premium Grain Cowhide Insulated Driver XL	\$17.99

***LIMITED AVAILABILITY**

PHONE (800) 569-2700



Elvex RSG series Features:

- Sunglass style with wraparound lens - Soft, black rubber temple tips for extra comfort and secure fit
- Flexible, rubber nose bridge to prevent slippage
- Ballistic rated, tested to US Military Std MIL-PRF-31013 Impact Test - Complies with ANSI Z87.1-2010 (+) & CE-EN-166

PART #	DESCRIPTION	RETAIL
RSG100	Black Frame, Blue Mirror Safety Sunglasses	\$ 10.45
RSG200	Black Frame Red Mirror Safety Sunglasses	\$ 10.45
RSG300	Black Frame Silver Mirror Safety Sunglasses	\$ 10.45
RSG301	Black Frame Blue Blocker Safety Sunglasses	\$ 10.45

Elvex Sphere-X Ultimate Features:

- Excellent industrial grade protection in a contemporary angular wrap style and with wide field of vision
- Soft, self-fitting rubber nose bridge conforms to a wide range of bridge sizes to enhance comfort and a secure fit
- Ballistic Vo rated for impact protection - 7x ANSI Z87+ energy (4x Z87+ impact velocity)
- Tested to US Military Standard MIL-PRF-31013 Impact Test - Meets ANSI Z87.1-2010 (+)

PART #	DESCRIPTION	RETAIL
SG51A	Sphere Exul Amber Safety Sunglasses	\$ 5.19
SG51BB	Sphere Exul Blue Blocker Safety Sunglasses	\$ 5.19

Elvex QuieTunes 660 ear muffs that off electronics that have been designed specifically and this has resulted in a contemporary and functional product. The electronics have been separated from the hearing protection cavities in order to avoid the problems that are associated with moisture and sweat affecting the life span. Now with an improved sensitivity and station lock with new quality components.

PART #	DESCRIPTION	RETAIL
COM660	Ear Muff Quiet Tunes - AM/FM Radio	\$114.00
COM655	Ear Muff Level Dependent - blocks high decibal	\$ 99.00



PART #	DESCRIPTION	RETAIL
DCTHI	Docker Lined Work Gloves Rigger Gloves w/ #M Thinsulate protection Tested to -30°C, reinforced seams and elastic back	\$ 8.19



MISCELLANEOUS LINES

CLEAN FUNNELS

2 SCREW ON LIDS TO KEEP OIL IN AND DIRT OUT.

DIFFERENT SIZES AND DIFFERENT COLORS FOR CODING.

PART #	SIZE	LNGLH.	SPOUT	COLOR	RETAIL
CF112	1 Pt.	6"	Vinyl Tubing	Turquoise	\$7.50
CF115	1 Pt	8.5"	15mm Straight	Orange	\$5.49
CF415	1.5 Qt	17"	15mm Flex	Red	\$7.49
CF315	1.25 Qt	13.5"	9/16" Straight	Lt. Blue	\$6.49
CF438	1.6 Qt.	14.25"	1-3/8" Flex	Red	\$8.75



CF415



CF115



CF315



CF438

SERVICE ORDER
NO. 4382801

EQUIPMENT MODEL _____ **DATE** _____

NAME _____ SERIAL NO. _____ NAME OF EQUIPMENT _____
 TYPE OF SPEC. NO./HOURS _____ TYPE OF EQUIPMENT _____

ADDRESS _____ CITY _____ STATE _____ ZIP _____
 SERIAL/CODE NO. _____ ENGINE/TRANS. MODEL NO. _____

DATE IN _____ DATE PROMISED _____ PHONE H _____ W _____
 DEALER PICKUP/DELIVERY _____ CUSTOMER DELIVERY/PICKUP _____

TUNE-UP	OVERHAUL	REPAIRS NEEDED	REPLACE WORKS	SAFETY LOCK	LUBEGATE SWOSSE	CHANGES	REWORK	SHARPEN BLADE	CUTTER COMPONENT	CHECK CHARGING CIRCUIT	SAFETY INTERLOCK	AIR BLOWER	CHECK STARTER	CHECK CONTROL	COMPRESSION	VALVE COOLING	WARRANTY DEFERENTIAL DATE OF PURCHASE	DATE OF FAILURE	ESTIMATE #	REORDER

CUSTOMER COMMENTS:

WORK PERFORMED:

SUMMARY

PARTS	
LABOR	
GAS - OIL - LUBE	
PICKUP/ DELIVERY	
FREIGHT	
SUB TOTAL	
TAX	
TOTAL	

IMPORTANT PLEASE NOTE

While the manufacturer may warrant the goods sold to the customer, we make no warranties, express or implied, including any implied warranties of merchantability or fitness, with respect to such goods.
 Not responsible for loss or damage in case of fire, theft or any other cause beyond our control.

I hereby authorize the above repair work to be done along with the necessary material and hereby grant you and/or your employees permission to operate the unit if necessary for the purpose of testing and/or inspection. I express my complete knowledge and agree to secure the amount of repairs thereto.

FULLY UNDERSTAND THE PURPOSES OF THE SAFETY DEVICES ON THIS EQUIPMENT AND REQUEST THAT THEY NOT BE REPAIRED OR REPLACED, AND I WILL ASSUME RESPONSIBILITY FOR AND HOLD YOU HARMLESS FROM ANY INJURY THAT MAY RESULT THEREFROM.

Part # - ESA200H
 ESA FORMS
 SERVICE FORMS
 PACKAGE OF 200

DEALER - \$45.00

Forms are 3 part carbons, individually numbered with a removeable tag for customers machine. Spaces for customer name, address, phone, customer comments, repairs made, parts used, labor, oil, freight. Also a place for customer authorization signature.

MISCELLANEOUS LINES

PHONE (800) 569-2700



TORK SHOP TOWELS



PART #
192592

DESCRIPTION
Shop Max Wet Wipes in Bucket
72 Pre-Moistened Clothlike sheets

RETAIL
\$18.95

440278

Blue Industrial Paper Wipers
Fan Folded - 90sheets - Recycled

\$12.50



450175

Heavy Duty Multipurpose Wiper
Self dispensing center feed box
- 90 sheets

\$10.50



450304

Heavy Duty Multipurpose Wiper
Large Roll - Blue
- 800 perforated sheets

\$67.50



MISCELLANEOUS
LINES

FAX (800) 489-4804

The Groundskeeper II

*It's Lightweight and Self-Cleaning

*No Down Pressure Needed

*Replaceable Tines



USED FOR:

- * General Debris Clean-Up
- * Cleaning Animal Bedding in Stalls
- * Leveling Dirt/Ground Preparation
- * Leaf Clean-Up
- * Spreading Mulch

- * Grooming Golf Course Bunker
- * Leveling Bedding Material
- * Job Site Clean-Up
- * Spreading Rock / Gravel
- * De-Thatching

***MANY MORE USES AROUND THE FARM, YARD, AND RANCH!!**

PART #	DESCRIPTION	RETAIL
GK102R	Groundskeeper Rake Full 21" 28 Tines, 55" Handle	\$26.95
GK112R	Groundskeeper Rake Shrub 9" 12 Tines, 55" Handle	\$23.95
GK122R	Groundskeeper Rake Spot 9" 12 Tines, 36" Handle	\$21.00
GK132R	Groundskeeper Rake Gardener 6" 8 Tines, 18" Handle	\$16.95
TK14	Replacement Tine Kit	\$ 7.50

MISCELLANEOUS
LINES

PHONE (800) 569-2700

EZ KUT



<u>PART #</u>	<u>DESCRIPTION</u>	<u>RETAIL</u>
<u>PRUNING SHEARS</u>		
3130	Pruning Shears - Green	\$ 29.99
3130CBOGR	Pruning Shears - Green COMBO PACK <i>includes carrying pouch and sharpener</i>	\$ 54.00
3130PNK	Pruning Shear - Pink	\$ 29.99
3130CBOPK	Pruning Shears - Pink COMBO PACK <i>includes carrying pouch and sharpener</i>	\$ 54.00
KM-1M	Turbo Force Pruning Shears	\$ 36.99

FOLDING SAWS

EZ-5210	WOW Folding Saw	\$ 34.99
KK330H	Kamikaze MAX Saw	\$ 42.00



LOPPERS

3110QA	Ratchet Loppers Extendable	\$ 59.99
EZ7684	G2 Large Loppers Extendable	\$125.00

POLE SAWS w/ KAMIKAZE BLADES

PST-14	14 FT Extendable Pole Saw - TURBO	\$179.00
PST-19	19 FT Extendable Pole Saw - TURBO	\$189.00

ACCESSORIES

3100EZ5	Carbide Sharpener	\$ 13.25
---------	-------------------	----------



MISCELLANEOUS LINES

orders@boettchersupply.com

Wobbler Sprinklers

Outstanding Uniformity
Droplet Size Resists Wind Drift
Only One Moving Part for Long Life
Sturdy Steel Sled Construction

Walker Wobbler
PART # WLS

Large Coverage Area: 50 ft.
Flow: 6 gpm, Pressure: 25psi

RETAIL - \$ 39.00



Walker Mini-Wobbler
PART # WSS

Large Coverage Area: 20 ft.
Flow: 3 gpm, Pressure: 25psi

RETAIL - \$ 38.00



REPLACEMENT PARTS

PART #	DESCRIPTION	RETAIL
WSHEAD	Small Wobble Head	\$ 8.95
WLHEAD	Large Wobble Head	\$12.00
WPC	1/2" Plastic Coupler	\$ 3.50
WEXT	3' to 7' Extension	\$ 4.50

PHONE (800) 569-2700

NOCO Jump Starters

Safely jump start a dead battery in seconds.

UltraSafe lithium jump starters from 400 to 4,000 amps,
plus USB power, light, and 12-volt portable power.



PART # 33-15359

The **GB20** is a portable, mini, pocket sized lithium-ion jump starter for 12-volt lead-acid batteries. It can safely jump start a dead battery in seconds, like on a lawn mower, car, boat, motorcycle, ATV, RV, truck and more. The GB20 is powered by a High-Density NOCO Element lithium-ion battery that can hold its charge up to one year, and handle over 1,000 cycles. Ultra-Bright Dual LED Flashlight With 7 Modes, including SOS and Emergency Strobe. USB Power. Recharge virtually any USB device, including Smartphones and tablets.

RETAIL - \$99.95



PART # 33-15365

The **GB40** is powered by a High-Density NOCO Element lithium-ion battery that can hold its charge up to one year, and handle over 1,000 cycles. LED Light. Ultra-Bright Dual LED Flashlight With 7 Modes, Including SOS And Emergency Strobe. USB Power. Recharge Virtually Any USB Device, Including Smartphones And Tablets. Noco Since 1914. It's rated at 1,000 Amps. Includes 40" USB to Micro USB Cable, 12V & HD Battery Clamps. Recharge virtually any USB device, including Smartphones and tablets.

RETAIL - \$124.95

Heavy Duty



PART # 33-15534

The **GB70** is a portable lithium-ion battery jump starter with:

- ** A lithium battery jump starter rated at 2,000 amps.
- ** Spark-proof connections and reverse polarity protection
- ** Recharges USB devices, like smartphones, tablets and more
- ** Power 12V devices anywhere, like tire inflators, power inverters, and more
- ** 400 lumen LED flashlight with multiple modes, inc. SOS.
- ** Jump start gas engines up to 8 liters, and diesel engines up to 6 liters
- ** Provides up to 40 jump starts on a single charge

RETAIL - \$259.00

Heavy Duty



PART # 33-15535

The **GB150** is a portable lithium-ion battery jump starter with:

- ** A lithium battery jump starter rated at 4,000 amps.
- ** Spark-proof connections and reverse polarity protection
- ** Recharges USB devices, like smartphones, tablets and more
- ** Power 12V devices anywhere, like tire inflators, power inverters, and more
- ** 500 lumen LED flashlight with multiple modes, inc. SOS.
- ** Jump start gas engines up to 8 liters, and diesel engines up to 6 liters
- ** Provides up to 80 jump starts on a single charge

RETAIL - \$395.00

FAX (800) 489-4804

MISCELLANEOUS LINES

Rope RATCHET[®] TIE-DOWN

The easy-to-use **ROPE RATCHET** is the answer to all your tie-down needs for work or play. The patented design and rugged construction lets you secure a wide variety of loads quickly and easily.

With the **ROPE RATCHET** you simply attach the two hooks and pull the loose end of the rope for a secure, tight hold. **ROPE RATCHETS** stay tight, locking in place as you pull the free end. To loosen you just pull the rope to reduce tension and push the handy thumb release.

It's that easy!

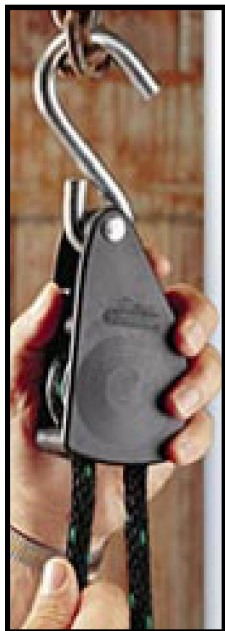

PART #	DESCRIPTION	RETAIL
RR10010	1/4" w/ 8 foot Rope <i>Maximum Load Limit: 150 LBS.</i>	\$10.50
RR10020	3/8" w/ 8 foot Rope <i>Maximum Load Limit: 250 LBS.</i>	\$14.99
RR10030	1/2" w/ 8 foot rope <i>Maximum Load Limit: 500 LBS.</i>	\$29.99
RR10035	1/2" w/ 15 foot rope <i>Maximum Load Limit: 500 LBS.</i>	\$30.99
HH20	Hang 'Em High Hoist w/ 20' Rope <i>Maximum Load Limit: 250 LBS.</i>	\$31.99

PHONE (800) 569-2700



Earthway Products, Inc., started in 1965, is a family owned company based in North Central Indiana. EarthWay® designs, engineers, and manufactures high quality lawn and garden products used by homeowners and professionals alike worldwide. The EarthWay®EV-N-SPRED® brand is recognized as a leader in broadcast spreading, and our products are sold under some of the most recognized names in the fertilizer, seed, and lawn and garden industries. All of our spreaders, sprayers, and seeders are produced at our world headquarters located in Bristol, Indiana.

GARDEN PRODUCTS				
Model #	Description			Retail
EW1001-B	Alum Seeder, 6 precision seedplates, adj depth, 30" mrk			\$139.99
RESIDENTIAL SPREADERS				
Model #	Wheel Size	Capacity	Spread	Retail
EW2030	8" Plastic	65 lb	8-10 ft Broadcast	\$ 55.00
EW7312 (Drop)	12" Semi-Pneum	65 lb	22" Drop	\$135.00
ESTATE SPREADERS				
Model #	Wheel Size	Capacity	Spread	Retail
EW2050P	10" Plastic	80 lb	8-12 ft Broadcast	\$139.00
EW2050T (Tow)	10" Plastic	80 lb	8-12 ft Broadcast	\$ 89.00
EW2600A	8" Semi-Pneum	40 lb	8-10 ft. Broadcast	\$ 89.99
COMMERCIAL SPREADERS				
Model #	Wheel Size	Capacity	Chassis	Retail
EW2150	13" Pneumatic	50 lb	Powder Coated	\$235.00
EW2170	13" Pneumatic	100 lb	Powder Coated	\$249.00
EW2170SS	13" Pneumatic	100 lb	Stainless Steel	\$315.00
HAND OPERATED SPREADERS				
Model #	Hopper Style	Capacity	Spread	Retail
EW3400	Plastic	2 lb	4-8 ft Broadcast	\$ 25.99
EW3100	Plastic Professional	40 lb	10-15 ft Broadcast	\$149.00
PROFESSIONAL SPREADERS				
Model #	Wheel Size	Capacity	Chassis	Retail
EWC22HD	13" Pneumatic	50 lb	Powder Coated	\$262.00
SPREADER ACCESSORIES				
Model #	Description			Retail
EW77001	Heavy Duty Rain Cover (2150 Series & C22 series)			\$ 29.00
EW77002	Heavy Duty Rain Cover (2170 Series, C24, C25, M21, M40)			\$ 34.00
EW77003	Heavy Duty Rain Cover (2030 & 2050 Series, M20)			\$ 32.00



EarthWay®



12 VOLT SPREADERS AND ACCESSORIES

Model #	Frame Type	Capacity	Control	Retail
EWM20	ATV Rack Mount, Powder Ctd	80 lb	Hand Operated Cable	\$ 219.00
EWM30	ATV Rack Mount, Powder Ctd	120 lb	Hand Operated Cable	\$ 359.00
EWM21P	Quick Connect, Powder Ctd.	100 lb	Spring Return Pull Cord	\$ 405.00
Mounts Required - see below includes wiring harness				
EWM80ECM	ATV 12 volt Stainless Steel	250lb.	All Electric, push button	\$1499.00
EW77011	Universal Mount Kit for M21 Series			\$ 55.00



**Prices limited to
IN-STOCK items
ONLY!!**

PHONE (800) 569-2700

**EARTHWAY
SPREADERS**

Hydro



MODEL	RETAIL
<u>OIL FIRED PORTABLE DIESEL</u>	
HC3200L	\$4695.00
<u>GAS ENGINE - OIL FIRED PORTABLE DIESEL</u>	
HCP3250L - 7HP SUBARU	\$5895.00
<u>COLD WATER WASHER</u>	
HCP4350COLD	\$3295.00

Standard Equipment:

- Heavy Duty Shut-Off Trigger Gun
- Unloader Valve
- Fuel Solenoid Valve
- Water Temp. Control Switch
- High Capacity Fuel Filter
- Quick Disconnect HP Hose Couplers
- 50' hose w/ 50' Reel
- 100' hose w/ 150' Reel
- Wand Holster / Hose Rack
- Stainless Steel Water Breaker Tank & Float Valve
- Pressure Switch for Burner Control
- High Efficiency Heating Coil
- Nozzle Holders
- Pressure Reducing Wand
- Relaxed Action Trigger

OFF HYDRO CLEANER Diesel Fired Portable High Pressure Washer							
MODEL/OFP	2512	3200	3822	5180	4300	5220	5520
VOLUME (GPM)	2.5	3	3.8	5	4	5	5.5
PRESSURE (PSI) AT PUMP	1200	2000	2200	1800	3000	2200	2000
MAX. OPERATING TEMP.	195 F	195 F	195 F	195 F	195 F	195 F	195 F
MAX B.T. U. PER HOUR	280,000	300,000	400,000	425,000	400,000	425,000	450,000
FORCED AIR WITH ELECTRONIC IGNITION							
FUEL TYPE	#1 OR #2 DIESEL						
S/S FUEL TANK SIZE	4.75 GAL	4.75 GAL	4.75 GAL.	6.50 GAL.	6.50 GAL.	6.50 GAL.	6.50 GAL.
EXHAUST STACK DIAMETER	8"	8"	8"	8"	8"	8"	8"
COIL SPECIFICATIONS	1/2" SCHEDULE 80 PIPE						
PUMP	TRIPLEX CERAMIC PLUNGER OIL BATH PUMP						
ELECTRIC MOTOR HP	2	4	5	6	7.5	7.5	7.5
VOLTAGE / PHASE	120V/1PH	230/1PH	230/1PH	230/1PH	230/460 1/PH / 3 PH	230/460 1/PH / 3 PH	230/460 1/PH / 3 PH
FULL LOAD AMPS	22A	19A	23A	29A	36A 1PH 25/14A 3PH	36A 1PH 25/14A 3PH	36A 1PH 25/14A 3PH
ELECTRICAL CONTROL	THREE POSITION ROTARY SWITCH OFF/RUN COLD / RUN HOT						
FRAME	16 GAUGE STAINLESS STEEL						
GFCI	32'GFCI CORD WITH PLUG		10' CORD W/GFCI OPTIONAL				
BYPASS SYSTEM	EXTENDED BYPASS SYSTEM FOR LONGER PUMP LIFE						
MOUNTING	CONVENIENTLY PORTABLE ON PNEUMATIC WHEELS						
HOSE	50' W/REEL		100 FT. WIRE-BRAIDED HOSE WITH QUICK COUPLERS / REEL 150'				
FLOW CONTROL	RELAX ACTION TRIGGER GUN WITH PRESSURE REDUCING WAND						
SOAP INJECTION	HIGH PRESSURE CONTROLLED BY METERING VALVE						
NOZZLES	COLOR CODED QUICK CHANGE 0,15,40 DEG.						
LENGTH (IN.)	44	44	44	47	47	47	47
WIDTH (IN.)	24	24	24	28	28	28	28
HEIGHT (IN.)	43	43	43	46	46	46	46
APPROXIMATE WEIGHT	335	348	348	447	500	500	500

HYDRO CLEANERS

FAX (800) 489-4804

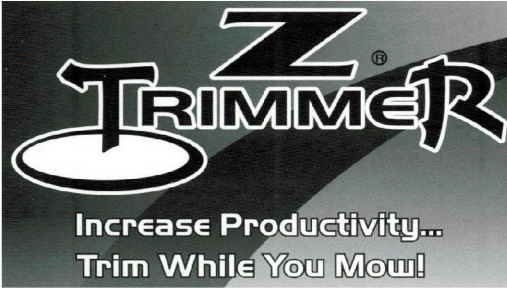

Designed to save time in lawn maintenance, the All New PECO Z-Trimmer attaches to virtually any zero-turn mower deck and is fully operable from the operator's seat.

Features include a spring loaded 2-way break-away platform that functions when encountering an obstacle, adjustable head for trimming/edging and has a 20" reach from the mower deck. Folds out of the way for easy transport!

FEATURES:

- DC Motor with sealed end engine cap
- Operating range 10-30 amps
- Easily Folds for Transport
- Shaft Debris Shield
- Cast aluminum fixed head
- Resettable circuit breaker prevents mower battery overdraw
- 140 degree range of head movement for trimming or edging
- 20" reach from the edge of the mower deck
- Transport lock - prevent trimmer movement while not in use
- Powerful DC motor with sealed end cap spins at 4600 RPM
- Increase productivity on zero turn mowers
- Quick and easy assembly
- Recommended for mowers w/ 48" decks or larger and having at least 20" of clearance from edge of deck to mower frame

<i>PART #</i>	<i>DESCRIPTION</i>	<i>RETAIL</i>
ZT-3000	Z-Trimmer Attachment	\$349.00

Z-TRIMMER

PHONE (800) 569-2700



Since 1988, Encore has served the mowing industry with a full line of high quality mowers that get the job done right the first time. With easier maintenance, precision blade alignment, and tough durability plus an industry leading warranty, Encore has a mower for you!



**TRIED &
TRUE!**

***Looking for New Dealers
in Kansas, Nebraska,
Iowa and Missouri!!
Call us today to set up a Demo!!***

TRACER



RAGE



ENCORE



**SINGLE STICK EDGE
NOW AVAILABLE!!**



PHONE (800) 569-2700

ENCORE



T-5500

Pro-Lift



T-5500
w/ T-5510 adapter

- Up to 20" lift from ground to wheel saddle for maximum space.
- Easy, convenient hydraulic powered foot pedal operation.
- Welded solid steel construction.
- Positive Dual locking safety latch for added safety.
- Four steel wheels for sturdy mobility.
- Powered by a 2-Ton-Hydraulic Bottle Jack

PART #	DESCRIPTION	RETAIL
T-5350	350 lb capacity Mower Lift	\$225.00
T-5500	750 lb capacity Mower Lift	\$495.00
T-5510	Push Mower Adapter-fits T5350,T5500,T5501	\$ 65.00



EA56 Edge Artist - The new Edge Artist landscape edger by E-Z Trench is the machine of choice for a value priced alternative. It utilizes the patented Bedscaper® blade design, focusing 5.5hp into small bites, easily cutting through hard soils and is ideal for redefining or edging for anyone who wants a manicured, professional looking edge.

BE300, Bedscaper - This Bedscaper bed edger has the added durability of a centrifugal clutch that is bathed in oil. The centrifugal clutch drive that is bathed in oil provides protection against extreme conditions and abuse.

PART #	DESCRIPTION	RETAIL
*EA56	5.5HP Honda Cent. Clutch Edge Artist	\$2156.00
*BE300	5.5HP Honda Belt Drive Bedscaper	\$2495.00

**LIMITED AVAILABILITY*



- ◆ 12" x 84" - 1,000 lb capacity - Arched for clearance
- ◆ 8 Heavy Duty rubber tipped fingers for gripping
- ◆ Serrated cross bars for superior gripping no matter how wet your tires are.
- ◆ Perfect for riding lawn mowers, ATV's Golf carts, etc.



73252

PART #	DESCRIPTION	RETAIL
73252	12" x 84" Ramp Set	\$185.00



48CP



4048P



PART #	DESCRIPTION	RETAIL
1084A	Aluminum Folding Ramp Set 84" x 14.5" x 2" - 1500lb Cap.	\$179.00
1084C	Steel Folding Ramp Set 84" x 10.5" x 2" - 1200lb Cap.	\$135.00
1084	Steel Folding Ramp Set 84" x 14.5" x 2" - 2000lb Cap.	\$139.00
42CP	42" Corer/Plugger, 40" width	\$275.00
42CPA	42" Corer/Plugger/Aerator, 40" width	\$149.00
24043	9 cu. ft. Steel Dump Cart, 350 lb. cap.	\$140.00
24413	8 cu. ft. Plastic, Non-Dump Cart 300 lb cap.	\$129.00
3048HKD	10 cu. ft. Wloded Steel Dump, 1000 lb. cap.	\$209.00
4048P	12.5 cu ft. Plastic Dump Cart, 750 lb. cap.	\$215.00

****LIMITED AVAILABILITY****

ANGLED CONSTRUCTION IS THE KEY

- **Allows maneuvers over the tailgate with ease.
- **Permits wheels to be in constant contact with surface eliminating spin of back wheels.
- **Reduce the risk of drag from the front deck of tractors.

ADDITIONAL FEATURES

- **Tailgate bar is double the length of competitors.
- **1500 lbs. (alum.), 2000 lbs (steel) capacity per set.
- **Patented folding and self-nesting design.

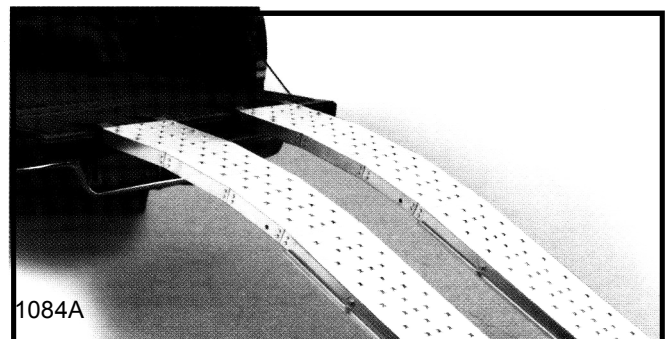

1084A

OHIO STEEL & RAMPS

PHONE (800) 569-2700

MID TINE MINNIE TILLERS

The Minnie Tiller is the smallest Mid-Tine® by MacKissic, but do not let the size fool you. The Minnie is a tough little tiller. The Mid-Tine® design places the weight of the machine on the tines, helping the tiller dig, and easing the burden off of the user. The Minnie Tiller is a versatile tiller that is great for a small garden.

PART #	DESCRIPTION	RETAIL
*MT4R	Minnie Tiler Robin 4.5 HP	\$1089.00
MT550IC	Minnie Tiller B&S 5.50HP	\$1149.00
MT4H	Minnie Tiller Honda 4 HP	\$1499.00



*LIMITED AVAILABILITY

SUBURBAN TILLERS

The Suburban Tiller is the choice of serious gardeners. The Suburban is great for just about any size garden, whether you need to break new ground, expand or create a new garden, The Suburban tills a 26 inch wide swath and can till up to 12 inches deep.

PART #	DESCRIPTION	RETAIL
ST750IC	Suburban B&S OHV IC 7.5	\$1349.00
ST6.5V	Suburban 6.5 Briggs Vang.	\$1649.00
ST5.5H	Suburban 5.5 HP Honda	\$1649.00



CALL FOR DEALER PRICING OR MORE INFORMATION!!

INTERNATIONAL TILLERS

The Merry Tiller® Mid-Tine® International Tiller is the best. There is no soil the International cannot handle. With more torque than the Suburban, the International powers through the soil quickly. The International is rental and commercial tough. This tiller will last for years without the costly maintenance that others require.

PART #	DESCRIPTION	RETAIL
IT950IC	International B&S 9.5HP OHV	\$1599.00
IT5.5H	International 5.5HP Honda	\$1899.00
IT6.5V	Intern. 6.5HP Briggs Vang.	\$1899.00



REAR TINE TILLERS

The Rear Tine Merry Tiller® is a strong, durable, and easy to use rear tine tiller. The tiller is self-propelled with three forward gears (two for tilling) and a reverse. The Rear Tine features counter-balance weights to focus the weight over the wheels. This allows for more control while tilling.

PART #	DESCRIPTION	RETAIL
RT1450IC	Rear Tine B&S 14.5HP OHV	\$3599.00
RT83H	Rear Tine 8 HP Honda	\$3949.00



****ACCESSORIES ON PAGES 96-97****

orders@boettchersupply.com

LEAF SHREDDER/CHIPPER

The LSC800 and the LSC1100 are small but tough machines built by MacKissic. They offer a small chipper chute which will chip branches up to 2-7/8 inches. The large hopper is designed to shred leaves. Perfect for small yard clean up!

PART #	DESCRIPTION	RETAIL
**LSC800	Shredder/Chipper 8 HP B&S	\$ 799.00
LSC1100	Shredder/Chipper 11 HP B&S	\$1299.00

****PRICE LIMITED TO INSTOCK UNITS ONLY!**



CALL FOR DEALER PRICING OR MORE INFORMATION!!

LEAFCYCLER

The LeafCycler by MacKissic is the 4-in-1 machine. The LeafCycler chips, shreds, blows, vacuums, and bags material! With ease a user can change from the blower to the vacuum.

PART #	DESCRIPTION	RETAIL
LC800EZ	4 in 1 LeafCycler B&S 8 HP	\$1169.00
VCB1102	Self-propelled B&S 11 HP Vacuum Bagger only	\$1999.00
VCB1102E	Self-propelled B&S 11 HP ES Vacuum Bagger only	\$2199.00



HAMMERMILL SHREDDER - CHIPPERS

If your lawn and garden debris cleanup is more than leaves and a few small twigs, one of MacKissic's Hammermill Style Shredder-Chippers is certain to exceed your expectations.

PART #	DESCRIPTION	RETAIL
SC800	B&S 8.0 OHV engine, 2-7/8" Chipper, Pneumatic Tires, loop handle	\$1549.00
12P1100	Wheelbarrow Unit, w/ B&S 11.00 OHV engine, 3-1/2" Chipper	\$2199.00
12PT8H	Trailer Unit, w/ Honda GX240 engine, 3-1/2" Chipper	\$2699.00
12PT1100	Trailer Unit, w/ B&S 11.00 OHV engine, 3-1/2" Chipper	\$2199.00
12PTE1100	Trailer Unit, w/ B&S 11.00 OHV Electric start engine, 3-1/2" Chipper	\$2549.00
SC1650E	B&S 16.5 OHV Electric Start engine, 4" chipper, non-highway towable	\$3899.00
SC1650HTE	B&S 16.5 OHV Electric Start engine, 4" chipper, highway towable	\$4249.00
SC185E	B&S ES 13.5HP, 4-1/2" Chipper, 1-1/2" Shredder, highway towable	\$5899.00
SC262-18VEMC	Chip-N-Shred Commercial Duty, 18HP Vanguard, hwy tires, 4" chipper	\$7699.00



Model 12PT1100



Model SC183



Model SC800

****ACCESSORIES ON PAGES 96-97****

PHONE (800) 569-2700

THREE POINT HITCH SHREDDER CHIPPER

MacKissic offers two three point hitch (TPH) shredder-chippers. Easily attached, these machines can handle just about anything you need shredded. Twigs and leaves and small branches even green and soggy material, these three point hitch shredder-chippers will pulverize, shred, and mulch the organic material.

PART #	DESCRIPTION	RETAIL
TPH-123	PTO Driven, 10-30HP Tractors	\$2099.00
TPH-184	PTO Driven, 16-45HP Tractors	\$3199.00



Model TPH184



Model TPH122

CALL FOR DEALER PRICING OR MORE INFORMATION!!

LEAF BLOWERS

Mighty Mac® leaf blowers by MacKissic create gale force winds between 160 mph and 200 mph to blow leaves and debris into neat windrows or piles. This gale is created by a balanced poly fiber reinforced impeller. This helps the machine run quieter and smoother. EZ Models have extra large rear pneumatic tires.

PART #	DESCRIPTION	RETAIL
LB800	Leaf Blower 8HP OHV B&S	\$ 819.00
LB800EZ	Leaf Blower 8HP OHV B&S	\$ 949.00
LB1100	Leaf Blower 11HP OHV B&S	\$ 989.00
LB1100EZ	Leaf Blower 11HP OHV B&S	\$1119.00
LB1450ICEZ	Leaf Blower 14.5HP OHV B&S	\$1249.00



STUMP CUTTER

The Stump Cutter by MacKissic is compact and portable with a reversible handle bar for front or rear cutting. Like its big brother, the Mini's unique operator position allows the user to see the stump and cutter head at all times during operation. Another "Meant To Rent" product by MacKissic.

PART #	DESCRIPTION	RETAIL
CPSC1450ICMC	B&S 13.5 OHV IC	\$3699.00
CPSC82HMC	Honda 8 HP engine	\$3999.00
*MSC6RMC	Mini - 6 HP Robin	\$2039.00



EASY AUGER

The #1 auger of choice by rental centers and contractors worldwide. Once you use a counter-balanced Easy Auger® hydraulic earth drill, you'll never use anything else.

PART #	DESCRIPTION	RETAIL
EA93H	Honda 9 HP	\$4499.00
EA93HSPT	Honda 9 HP Self-propelled	\$5699.00

EASY AUGER ACCESSORIES

850-0011	2" Hitch	\$239.00
AUGERS		
850-1365	2" X 36"	\$333.00
850-1407	4" X 36"	\$397.00
850-1410	6" X 36"	\$371.00
850-1413	8" X 36"	\$462.00
850-1419	10" X 36"	\$523.00
850-1366	2" X 42"	\$340.00
850-1408	4" X 42"	\$376.00
850-1411	6" X 42"	\$384.00
850-1414	8" X 42"	\$472.00
850-1420	10" X 42"	\$533.00



(More Optional Accessories Available)

****ACCESSORIES ON PAGES 96-97****

FAX (800) 489-4804

SPRAYERS

Mighty Mac® sprayers by MacKissic are powerful and versatile sprayers that will allow you to have a professionally looking lawn in less time than it takes to mow. Mighty Mac® sprayers are powerful enough to reach the tops of trees as tall as a three story house, yet can be gentle enough to water flowers with a fine mist.

PART #	DESCRIPTION	RETAIL
PS322TE	Tow Spray 22 gal. 12V (no batt)	\$ 769.00
PS322T	Tow Spray 22 gal 4.75HP B&S	\$1599.00
PS350T	Trailer Spray 50 gal, 4.75HP B&S	\$1999.00
PS350T-10	Commercial Trailer Spray, 50 gal B&S 8 HP, 10gpm pump	\$2699.00

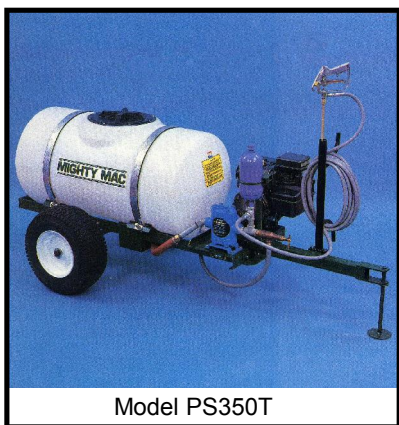

Model PS350T

PART#	DESCRIPTION	RETAIL
SPRAY BOOMS		
4NB	4 Nozzle, spray 80" wide	\$198.00
4NBE	4 Nozzle, spray 50" (PS322TE only)	\$198.00
6/8NSB	Combo 6&8 nozzle, sprays 120"	\$333.00
SPRAY ACCESSORIES		
100-0233	Surge tank (pulsation dampener)	\$415.00
100-0102	Brass Spray Gun Extension	\$ 51.00
100-0112	Extra 25' Hi Pressure hose w/ fittings	\$ 93.00
100-0112A	Extra 50' Hi Pressure hose w/ fittings	\$145.00
100-0112B	Extra 75' Hi Pressure hose w/ fittings	\$187.00
100-0112C	Extra 100' Hi Pressure hose w/ fittings	\$239.00
080-0026	Hose Coupler	\$ 22.00
100-0159	Pistol Grip Gun w/ extension	\$156.00
108-0082	Pull Handle Kit (PS322,322TE)	\$ 72.00
108-0083	Jet Agitation Kit (PS322,322TE) (standard on PS350T-10)	\$ 41.00
108-0084	Pressure Guage Kit (PS322,350T & -10)	\$ 83.00
108-0347	Spray Gun-std on PS322TE,	\$ 51.00
108-0409	1-1/2 Amp Trickle Charger on 12V	\$ 51.00

MIGHTY MAC WOOD CHIPPERS

The MIGHTY Mac wood chippers quickly tear through any kind of wood producing crisp chips perfect for landscaping and garden mulching. The combination of our heavier grade steel and a welded hopper neck allow for dependability, ease of use and low maintenance. The WC375 comes standard with a handle. The WC475/475E/575E come standard with yard tow. There is also an optional highway tow kit

PART #	DESCRIPTION	RETAIL
WC375	3-3/4", B&S XR1150	\$1499.00
WC475	4-3/4", B&S XR1650	\$2499.00
WC475E	4-3/4" B&S XR1650 ES	\$2699.00
WC575E	5-3/4", B&S XR1200 ES	\$3499.00
TPH475	4-3/4" Cat 1 PTO up to 45HP	\$1999.00



MERRY COMMERCIAL WOOD CHIPPERS

Merry Commercial dedicated wood chippers make quick work of green and dry branches. Features heavy steel flywheels, heat treated steel knives, centrifugal clutches, and greasable bearings, that will help to ensure years of dependable service.

PART #	DESCRIPTION	RETAIL
WC35MC	3-1/2", 10HP B&S Vng, Highway	\$2899.00
WC35HMC	3-1/2", GX270 Honda Highway	\$3299.00
WC45MC	4-1/2", 16HP Briggs Vng	\$4179.00
WC45HMC	4-1/2", GX290 Honda	\$4179.00
WC55MC	5-1/2", 16HP Briggs Vng	\$5499.00



****ACCESSORIES ON PAGES 96-97****

PHONE (800) 569-2700



PART#	DESCRIPTION / SIZE	RETAIL
TILLER ACCESSORIES		
MT951	Finger Tine Assemblies, right & left inside	\$208.00
MT952	Finger Tine Assemblies, right & left outside	\$208.00
MT956	Pick Tine Assemblies (1 Set)	\$365.00
MT1701	Slasher Tine Assemblies, right & left inside	\$177.00
MT1702	Slasher Tine Assemblies, right & left outside	\$177.00
MT1703*	Slasher Tine Extension Assemblies, right and left	\$177.00
MT1812	Bolo Tine Assemblies, right and left inside	\$177.00
MT1813	Bolo Tine Assemblies, right and left outside	\$177.00
MT1815	Bolo Tine Assemblies, right and left outside	\$177.00
MT1816	Bolo Tine Assemblies, right and left inside	\$177.00
MT2492	Aerator Assemblies (3 spoon), set of 4	\$365.00
MT3157	Minnie Slasher Tine Assy, left and right inside	\$156.00
MT3158	Minnie Slasher Tine Assy, left and right outside	\$156.00
MT3404	Lift Handle Kit (fits Suburban and International only)	\$ 29.00
MT3405	Lift Handle Kit (fits Minnie)	\$ 29.00
MT7801	8" Furrower	\$ 47.00
MT7802	10" Furrower	\$ 49.00
MT7875	Adjustable Plow Bar	\$103.00
MT7876	Spring w/ Pin System (Minnie w/ 2 pc wheel & drag bar system)	\$ 72.00
MT7877	One Piece Wheel & Drag Bar w. Spring (Minnie)	\$124.00
MT7878	Wheel & Drag Bar w/ Spring w/ Pin System (Suburban & International)	\$ 78.00
*These rotors fit between the basic and first extension rotos to provide full width.		
LEAFCYCLER ACCESSORIES		
704-0150	Hose Kit, 6" x 8' hose with pick up snout	\$239.00
705-0079	Replacement bag only	\$ 62.00
LEAF BLOWER ACCESSORIES		
705-0158	Front swivel/ locking Wheel Kit	\$135.00
705-0168	Lift Handle Kit	\$ 30.00
705-0169	Pull Kit	\$ 72.00
VACUUM-CHIPPER-BAGGER / VACUUM-BAGGER ACCESSORIES		
805-0189	Replacement bag only	\$135.00
805-0129	Hose Vac kit, 6" x 8' hose with pick up snout and adapter	\$271.00
WOOD CHIPPER ACCESSORIES		
930-4100	Light Kit	\$ 93.00
WC375 YTKIT	Yard Tow Kit for WC375	\$119.00
WCHDKIT	High Discharge Kit for WC475/475E/575	\$329.00
WCHWYKIT	Highway Tow Kit for WC475/475E/575	\$429.00
STUMP CUTTER ACCESSORIES		
807-0001	Cutter Teeth - straight / 807-0002-25 deg., 807-0003-45deg.	\$ 26.00
807-0070	Cutter Head Assembly	\$386.00
807-0159	Complete set of 9 cutter teeth	\$187.00
807-0092	Green Sharpening Wheel 6" x 3/4" w/ 1" bore	\$ 56.00
807-0093	Carbide Flap Wheel 4-1/2" x 7/8"	\$ 33.00

orders@boettchersupply.com

PART#	DESCRIPTION / SIZE	RETAIL
SHREDDER/CHIPPER ACCESSORIES		
Available for Models LSC Series		
804-0214	Standard replacement horizontal bar screen for Serial #419233 and up	\$ 67.00
804-0023	Slotted Bar screen for Serial #419232 amd below	\$ 67.00
705-0079	Replacement bag only	\$ 62.00
804-0068	Leaf & Shrub Vacuum kit, 4" x 10' with pick up snout	\$250.00
Available for Models, SC703 / SC705 / SC 752 / SC763 / SC800		
800-0015	Standard Replacement, 1" diameter hole screen	\$ 98.00
Optional screens: 800-0069 - 1/4", 800-0049 - 1/2", 800-0070 - 3/4"		\$ 98.00
800-0011	Optional oblong stamped bar screen (3" x 1-1/2" oblong openings)	\$ 98.00
800-0060	Optional rectangular welded bar screen (1-2/16" x 4-15/16" rec. opening)	\$135.00
800-0032	Water Resistant fitted cover	\$ 77.00
800-0144	Bagging Kit	\$135.00
800-0045	Replacement bag only	\$ 72.00
500-0013	Leaf Tamper	\$ 30.00
Available for Model Series 12P / PT / PTE and TPH-12 / TPH-122		
500-0004	Standard replacement 1" diameter hole screen	\$135.00
Optional screens: 500-0052 - 1/4", 500-0053 - 1/2", 500-0054 - 3/4"		\$135.00
500-0055	Optional oblong stamped bar screen (3" x 1-1/2" oblong openings)	\$135.00
900-0133	Optional rectangular welded bar screen (1-3/8" x 7-1/8" rect. Opening)	\$166.00
500-0013	Leaf Tamper	\$ 30.00
108-0082	Optional Pull Handle	\$ 72.00
908-0055	Water Resistant fitted Cover	\$ 88.00
900-0116	Bagging Kit for 12P / 12PT / 12PTE	\$135.00
900-0328	Bagging Kit for TPH122 / TPH123	\$135.00
800-0045	Replacement bag only	\$ 72.00
Available for models SC150-120E / SC150HT-12E / SC1650E / SC1650HTE		
910-0048	Standard screen: 1-1/4" diameter hol	\$198.00
910-0049	Optional 1-1/2" x 4-3/4" slotted screen	\$198.00
910-00064	Optional 3/4" screen	\$198.00
913-0066	Pull Handle Kit	\$ 72.00
Available for Models SC183 and TPH183 / TPH184 Brute		
921-0054	Standard scrrren: 5-5/8" x 1-1/2" oblong hole screen	\$250.00
Optional reduction screens: 3/4" - 911-0308; 1-1/4" - 911-0007		\$250.00
911-0069	Light Kit	\$ 98.00
911-0075	Water Resistant fitted cover	\$124.00
Available for Model SC260 / SC262 Chip N Shred		
912-2410	3/4" Diameter Hole Screen	\$281.00
912-2409	Discharge screen, standard bar grate	\$312.00
912-3530	Light and Fender Kit	\$250.00
912-3531	Tongue Jack Caster	\$ 46.00

solo

Solo Sprayers are built tough and made to last. That 's why they are the first choice of farmers, professional landscapers and do-it-yourselfers everywhere. In fact, Solo has earned global recognition for superior quality spraying equipment since 1948.

PART #	DESCRIPTION	RETAIL
460-LI	Hand Held Battery Op. 1 Liter Lithium Ion Battery, USB cable inc.	\$ 29.95
400-1G	1 Gallon Economy	\$ 11.95
405-US	1 Gallon Multi-Purpose	\$ 19.95
406-US	2 Gallon Multi-Purpose	\$ 21.95
430-1G	1 Gallon Farm & Landscape	\$ 33.80
430-2G	2 Gallon Farm & Landscape	\$ 35.75
430-3G	3 Gallon Farm & Landscape	\$ 40.95
454	1.25 Gallon Professional	\$ 49.95
456-2V	2.25 Gallon Professional	\$ 54.95
457-3V	3 Gallon Professional	\$ 59.95
453	3 Gallon Trolley-Wheeled	\$ 54.95
457-ROLLABOUT	3 Gallon Wheeled	\$ 67.95
469	2 Gallon Stainless Steel	\$123.95
425-101	4 Gallon / Piston Pump BackPack	\$ 99.99
475-B	4 Gallon / Diaphragm Backpack	\$103.99
417	4.5 Gallon - Battery Op. Backpack	\$189.00
424-LI	4 Gallon - Battery Op. Backpack Lithium Ion Battery, USB cable inc.	\$119.00



460-LI



405US-1G



454



424-LI



453



425-101

SOLO
SPRAYERS

Accessories and Parts Kits

solo

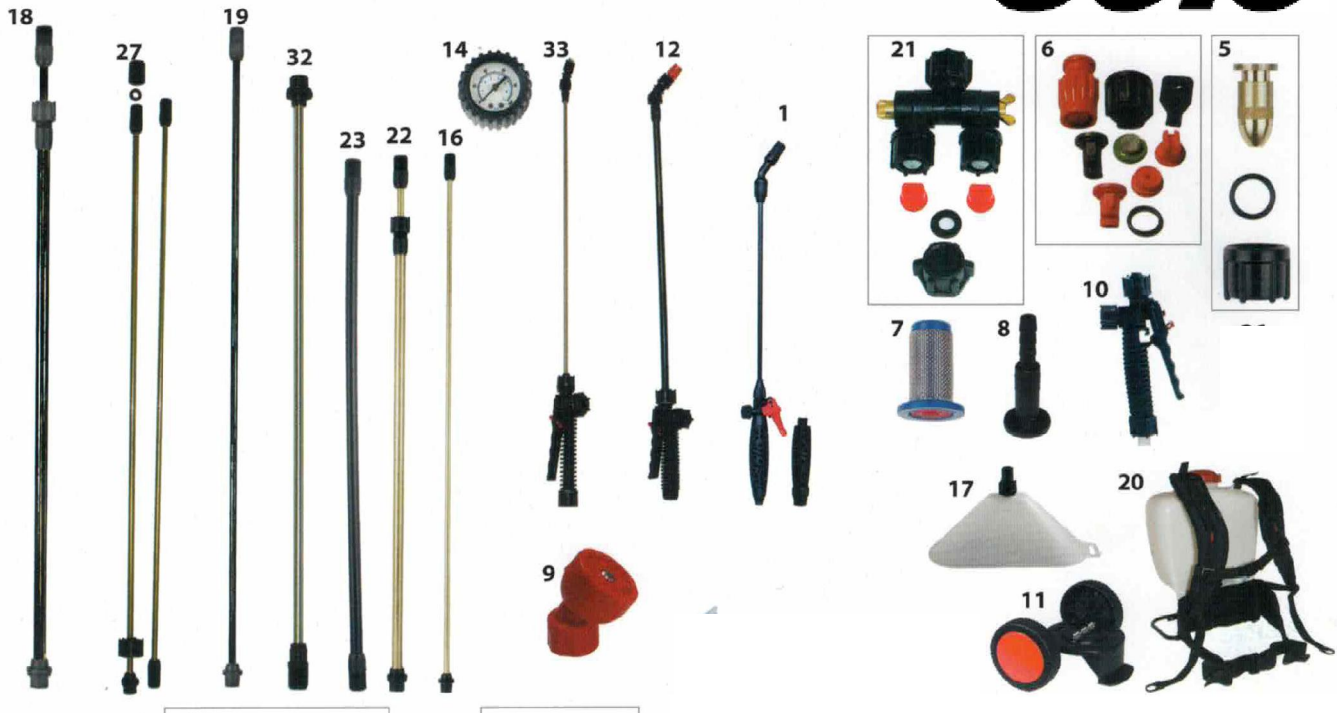

#	PART #	DESCRIPTION	FITS	RETAIL
1	8956-N	21" Universal Wand Assy	Universal	\$13.25
3	0610406-K	Diaphragm Pump Repair Kit	475-B,475-101\$ 485,473D,473ECS	\$14.95
4	0610407-K	Piston Pump Repair Kit	425,425-101, 435-473-P	\$19.95
5	0610410-P	Brass Adj. Nozzle Kit	All	\$ 8.75
6	0610456-P	Nozzle Assortment	All	\$12.95
7	2700316	No-Drip Check Valve	All	\$ 4.95
8	4074654	1/4 & 3/8 Hose Barb	For 4800170	\$ 2.95
9	4074666-P	Multi-Pattern "Speed Tip"	All	\$ 8.95
10	4800170-P	Shut Off Valve	All	\$15.95
11	4900110	Snap-On Wheels	456, 457	\$19.95
12	4900170N	28" Universal Wand Assy	All	\$19.95
13	4900299	4-Nozzle Spray Boom	All	\$59.95
14	4900622	Pressure Gauge	All	\$29.95
15	4900405-K	Pump Repair Kit	454, 456, 457	\$ 5.95
16	4900421	20" Brass Wand	All	\$12.95
17	4900430	Drift Guard	All	\$16.95
18	4900445	47"-90" Telescoping Wand	All	\$79.95
19	4900449	48" Spray Wand	All	\$39.95
20	4300343	Deluxe Shoulder Harness	425,473P.473D 435,475B,485	\$29.95
21	4900477	Double Spray Nozzle	All	\$29.95
22	4900478	20"-40" Brass Telescoping Wand	All	\$44.95
23	4900513	20" Extension Tube	All	\$16.95
24	4900514	2-Nozzle Spray Boom	All	\$34.95
27	4900528	60" Brass Wand	All	\$34.95
32	4900645-P	21" Stainless Steel Wand	All	\$11.95
33	4900647-P	29" Univ. SS Wand Assy	All	\$24.95

PHONE (800) 569-2700



NEW!!



**Now stocking
Toro Mowers,
Accessories
and Parts!**

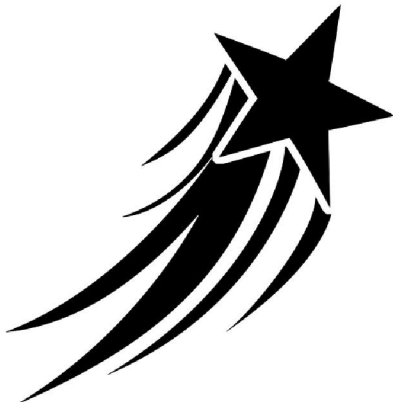

TORO



**JOIN THE PRO TEAM
AND CHOOSE THE MOST DEPENDABLE AND
POWERFUL OUTDOOR POWER EQUIPMENT!**



We now carry
Echo Handheld
Equipment,
Accessories and
Parts!

PHONE (800) 569-2700



ACCESSORIES

PART #	DESCRIPTION	RETAIL
*LKAB-629HB	Mini Bar Light Kit / Avenue/Boulevard	\$188.00
*MK48B-629HF	Mulching Kit, 48" Boulevard	\$127.00
*BLADE1-629DN	Push Blade/Jazee, Jazee 1, Edge	\$850.00
*JHPB-629DN	Push Blade/Jazee, Jazee 1, Edge	\$850.00

**LIMITED TO IN STOCK UNITS ONLY*

BELTS AND BLADES

PART #	DESCRIPTION	RETAIL
12-15667	<u>D-3727W</u> Deck Belt 1/2" x 146-1/4"	\$44.90
12-15668	<u>D-3733W</u> Deck Belt 1/2" x 160"	\$62.30
12-15669	<u>D-3775W</u> Deck Belt 5/8" x 161"	\$81.10
92-150	<u>H-1715</u> - Hi Lift Blade for 42" 1/2" ID	\$18.68
91-129	<u>H-2246</u> - Hi Lift Blade for 52" 1/2" ID	\$21.65
91-128	<u>H-1708</u> - Hi Lift Blade for 60" 1/2" ID	\$24.00
96-129	<u>H-2251</u> - Gator Blade for 52", 1/2" ID	\$20.40
96-724	Gator blade for 72" 1/2" ID	\$17.38
92-160	<u>H-2653/H-2882</u> Hi Lift Blade for 48" 5/8" ID	\$14.63
592-160	<u>H-2665</u> Gator Blade for 48" 5/8" ID	\$22.68
92-137	<u>H-2654/H-2883</u> Hi Lft Blade for 52" 5/8" ID	\$14.85

****PRICES SUBJECT TO CHANGE****

We carry the complete line of Country Clipper parts!

FAX (800) 489-4804



Made
in the
U.S.A.

COUNTRY CLIPPER

ZERO TURN MOWER



Avenue

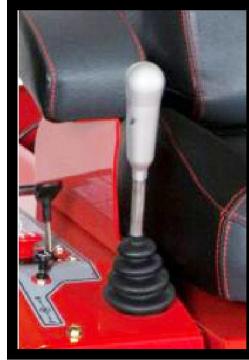

Boulevard

QTY	PART #	DESCRIPTION
1	1842KAJ-A110	AVENUE, 18HP KAW, 42" DECK
7	2354KOJ-A105	AVENUE, 23 HP KOH, 54" DECK,
1	2348KOJ-B210	BOULEVARD, 23HP KOH, 48"DECK
1	2354KOJ-B200	BOULEVARD, 23HP KOH, 54" DECK
2	2360KOJ-B205	BOULEVARD, 23 HP KOH, 60" DECK
1	2452KAJ-SR450	EDGE XLT, 24HP KAW, 52"DECK
1	2460KAJ-SR405	EDGE, 24HP KAW, 60" DECK
1	2454KAJ-C300	XLT, 24HP KAW, 54" DECK
1	2654KOJ-C300	XLT 26HP KOH, 54" DECK, JSTK

****LIMITED TO IN STOCK MOWERS ONLY.***

Most of these mowers are setup and will have to be delivered by our truck or the salesmen as schedules permit.

Freight charges will apply to units.

PHONE (800) 569-2700

ACCELERATOR GRASS CATCHERS

Accelerator is a lightweight steel mesh grass catcher that hangs from the side of your mower deck. Large handles and a big door allow for quick dumping of grass clippings. These grass catchers are made to fit a variety of side discharge lawnmowers from stand-on, wide area walk behinds, riders and zero turns.



PART #	DESCRIPTION	RETAIL
GCEX44	4.15 cubic ft. / 3.3 bushels	\$449.00
GCBBXL	6.2 cubic ft. / 5 bushels	\$559.00

Milwaukee Tool is an industry-leading manufacturer of heavy-duty power tools, accessories and hand tools for professional users worldwide.

Call for pricing today!!

ACCELERATOR & MILWAUKEE

orders@boettchersupply.com